

buspro | buspro
WIRELESS

CATALOG

Smart Systems for Homes, Commercial Buildings and Hotels



HDL Automation



HDL®



Residential



Hospitality



Commercial

Contents

buspro

01-02	What is Buspro?
03-04	Software
05-06	HDL Buspro Setup Tool
07-08	HDL ON
09-10	HDL Intelligent Hotel Management System
11-48	Control Panels, Panel Power Interfaces
49-80	Controllers / Actuators
81-90	Sensors
91-96	Gateways
97-100	Audio Devices
101-108	Infrastructure Devices / Accessories

buspro WIRELESS

109-110	Buspro Wireless
111-112	What is Buspro Wireless
113-124	Control panels
125-132	Controllers / Actuators
133-134	Sensors
135-138	Gateways



What is Buspro?

Buspro is a smart system for homes, commercial buildings and hotels. It is able to integrate lighting, shading, air-conditioning, floor heating, background music, security and more functionality and features, and allows users to control everything on a mobile app, PC program or wall panel. What's more, with sensors and logic settings, tasks can be automatically run by the system as well.

It is a wired system developed by HDL and runs on its proprietary communication protocol. So, it is also known as HDL Buspro.

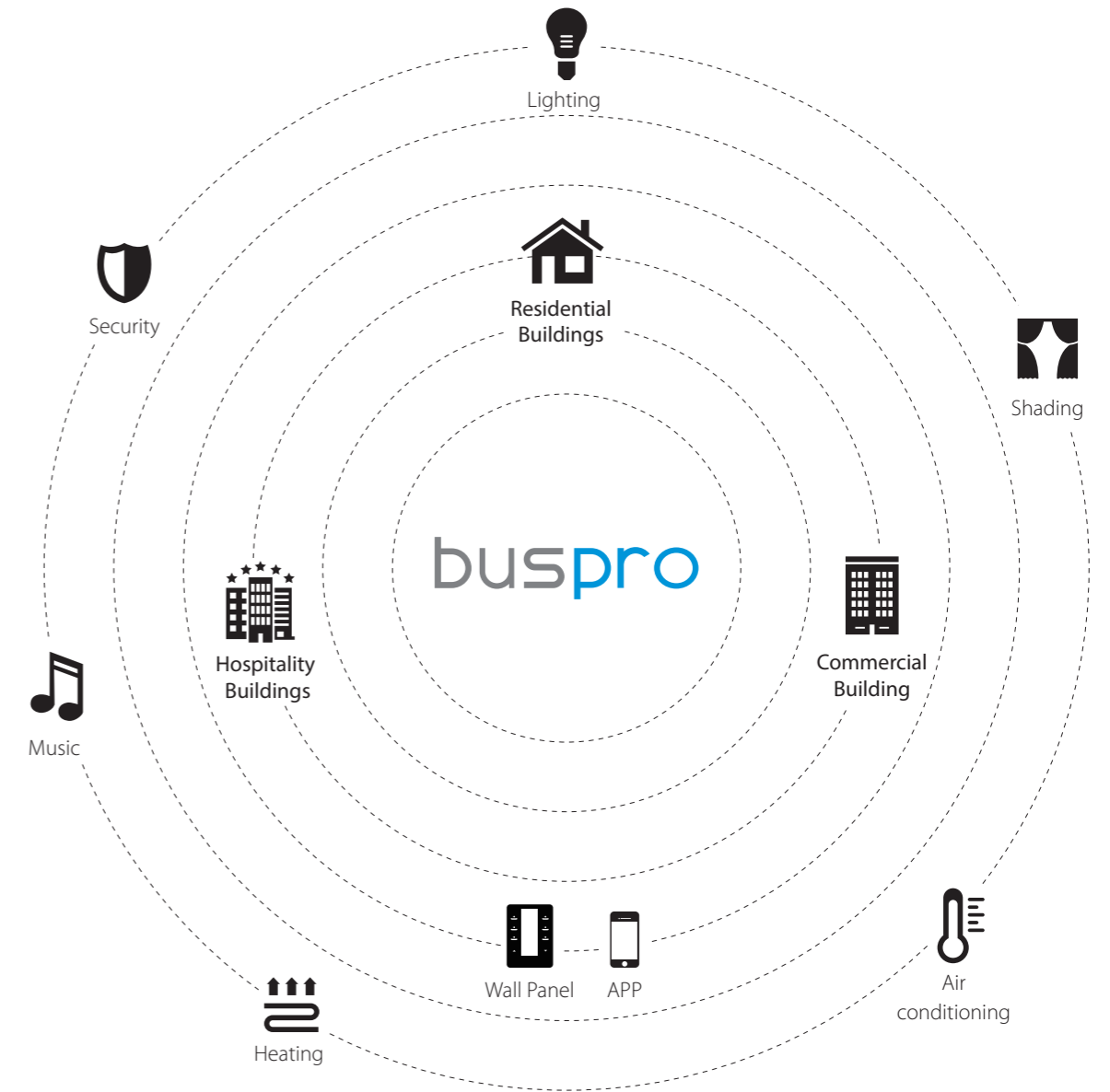

How does it work?

Buspro consists of software, control panels, controllers (or, actuators), sensors, gateways, audio devices and infrastructural devices. These devices make up a combination to serve for a certain project. And the "combination" of devices is called a solution.

A controller (say, a relay module) connects with the control target (say, a light bulb) through electrical wires on one side, and connects with the system via Buspro cables on the other side. For a minimum solution, we will need a power supply module to provide the solution with 24V DC power. Then we need a Buspro IP Gateway to link the system to the Internet, so that users can control the system with a phone or PC. More devices can be added to the solution for more features, such as a wall panel, sensor, logic module, etc.

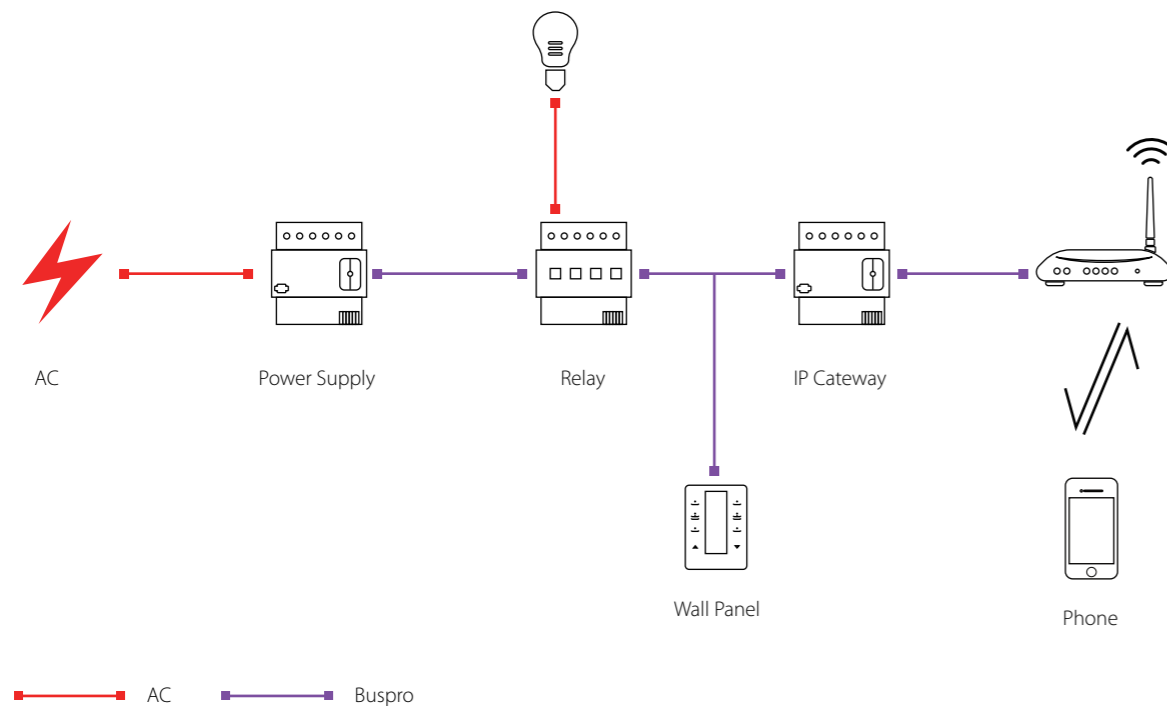

Topology of a minimum Buspro solution

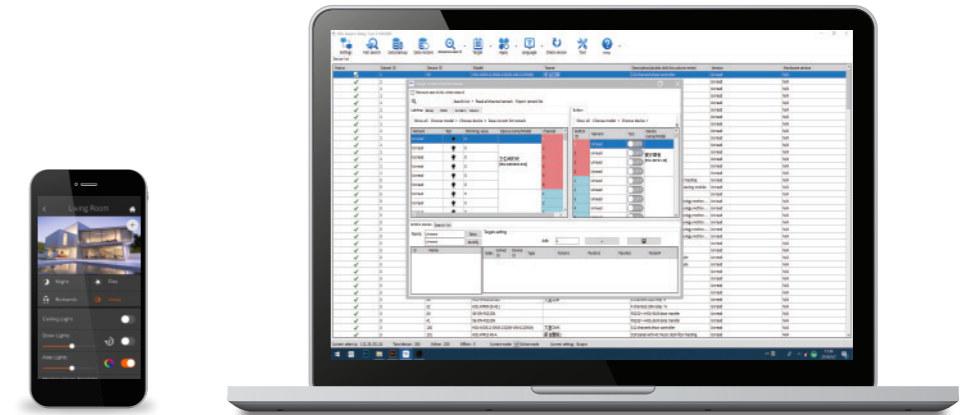

Here we briefly introduce to you:

- HDL Buspro Setup Tool. A program used to configure HDL Buspro.
- HDL ON. A mobile app offered by HDL for smart home users.

Software

Software is the most important interface that people interact with any smart systems. A user, either an engineer or end-user, will tell if a system is good or bad right from its software.

As a manufacturer of smart systems, HDL cares about the user experience provided by its products through software. Tremendous efforts are made to develop its in-house software and integrate with any possible third-party applications.

HDL Buspro Setup Tool

HDL Buspro Setup Tool (HBST) is the configuration application of HDL Buspro and Buspro Wireless. Installed on a Windows PC, it is designed for engineers to set up the IP addresses, parameters, logic conditions and other subjects in a solution.

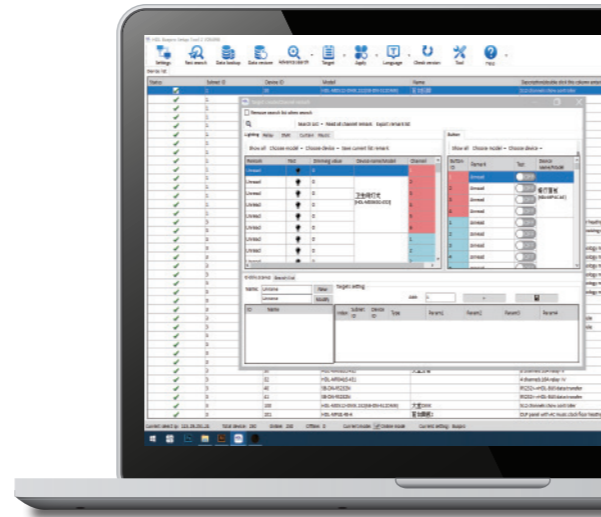

SHBT is the most frequently used PC application by engineers in HDL projects. You may use it to:



Modify a project's original settings



Examine a possible problem



Test a device



Setup a solution



And More

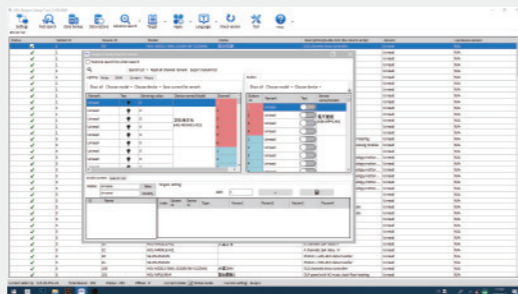
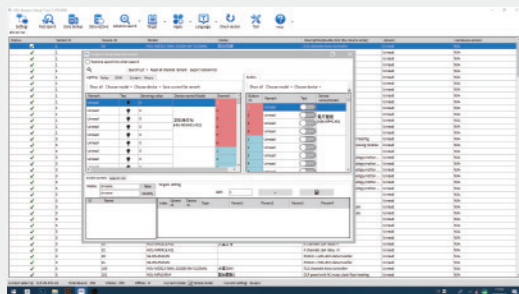
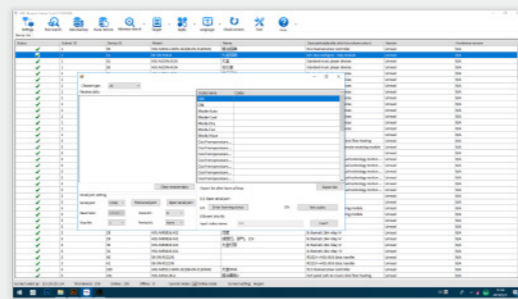
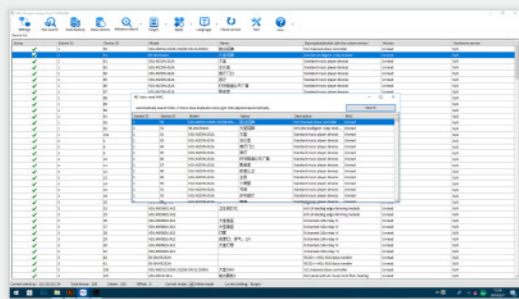

Screenshots of HDL Buspro Setup Tool



HDL ON

HDL ON is an official mobile app for smart home projects offered by HDL. The engineer sets up the solution on HBST and then imports the project file to this app. That's when it's ready for end users. With the beautiful and intuitive interface, users will love to use it.



iOS



Android



Simple solution for engineers.

For simple smart home projects, engineers don't always have to configure the system with HBST. They can do it with HDL ON as well. When the configuration is finished, the project data can be backed up on the cloud and restored to the app any time it is needed.

Easily control everything.

From lighting to shading, from music to air-conditioning, HDL ON enables you to control all functionalities in the system right on your phone. You can easily navigate on HDL ON by rooms or functionality to quickly get to what you want to control.



Lighting



Shading



Music



Air-conditioning

HDL Intelligent Hotel Management System

HDL Intelligent Hotel Management System (IHMS) works with HDL's smart hotel system. It enables the hotel to manage its guest rooms, room cards and services on a desktop computer, while allowing guest to control room devices via a wall panel, mobile app or smart speaker.

IHMS consists of the local server, cloud server, client, room cards management tool and APIs.

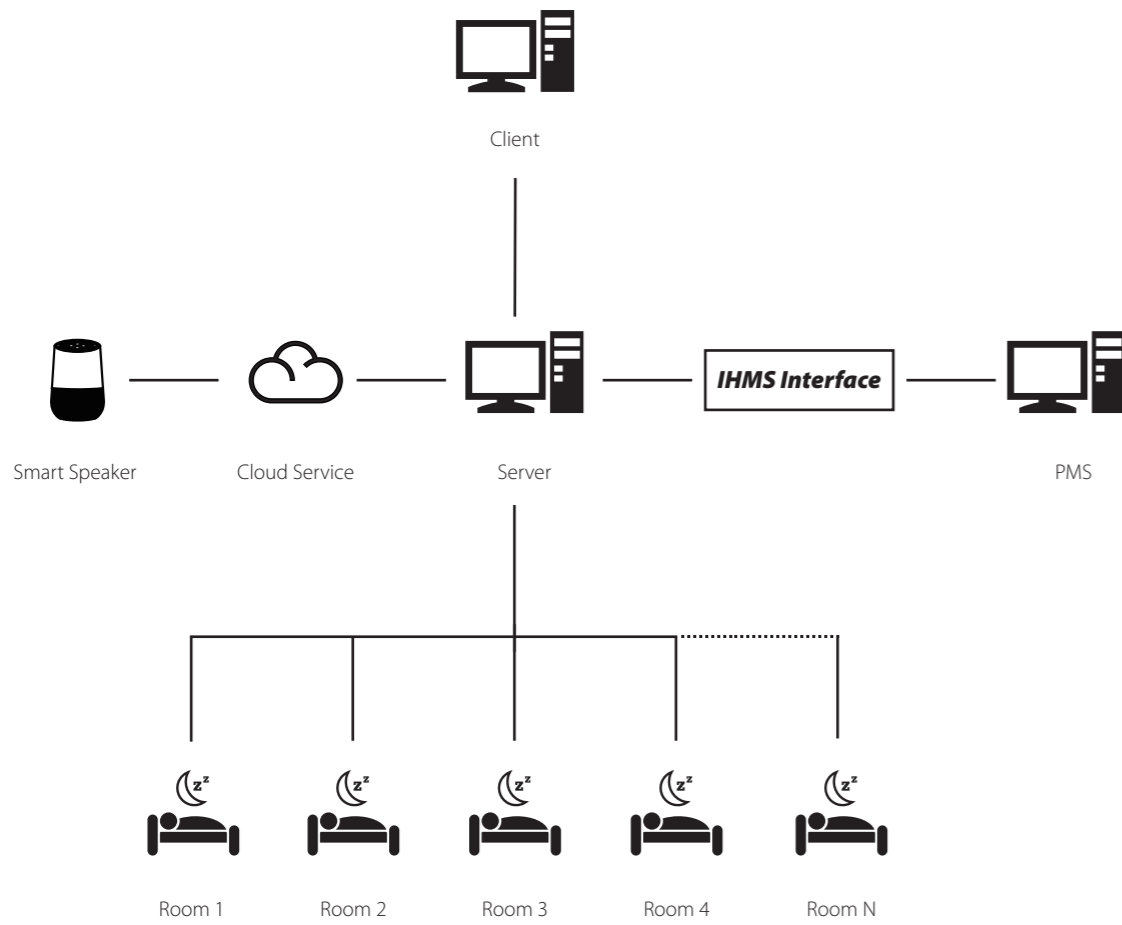

Topology of HDL Intelligent Hotel Management System



Server.

It syncs and updates the data of all connected clients.

Client.

It has a user-friendly interface. Hotel staff can view the room status and proceed service requests.

Cloud Service.

When the cloud service is enabled, hotel guest can control curtains, lights, HVAC and other devices via a mobile app or smart speaker.

It can integrate with PMS via its API.

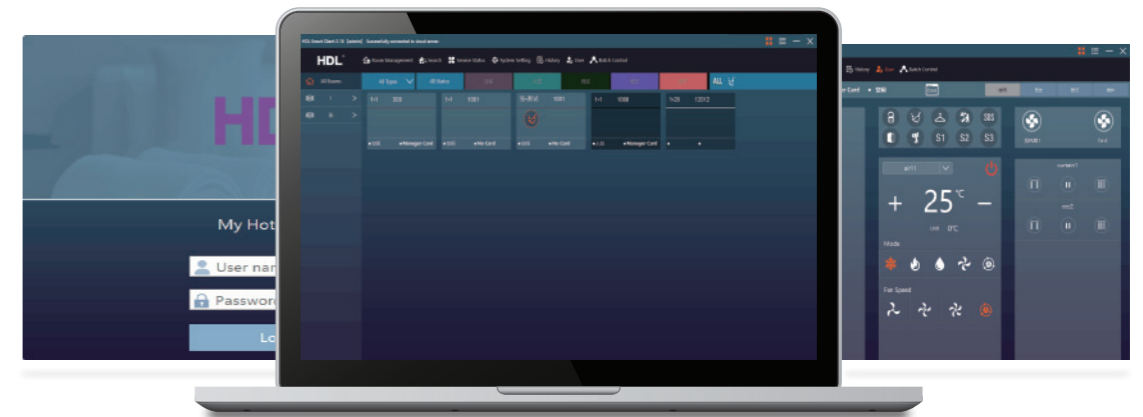

Control Panels

In most cases, people can use a mobile app to control everything connected to a smart system. However, control panels, or, most of the time wall panels, are essential to an automation project. The reasons are obvious.



Control
Panels

A wall panel is a redundancy or backup that guarantees you still have your devices under control when you are not able to use the mobile way. For example, in the case that when you lose your phone.

It is preferred by the users that don't like tweaking on a smart phone.

A wall panel possibly can serve as an ornament that adds credits to the aesthetics of the interior decoration of a building.



Granite Display



Meant to be eye-catching.

Granite Display is designed to be a gorgeous ornament making your place look better. Just a glance, you would be stunned by its extraordinary beauty.

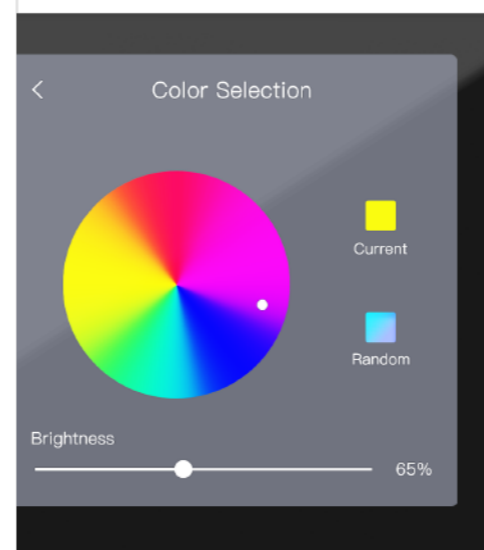

Granite Display
New Generation User Interface.

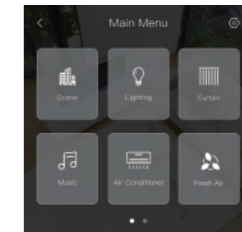

Main Menu



Air Conditioning

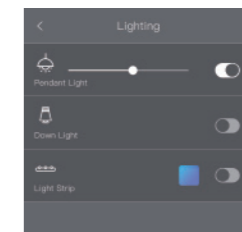

Lighting



Floor Heating

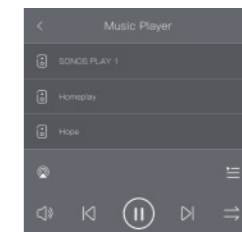

Music Player

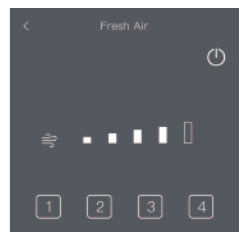

Fresh Air

Give it a touch, you would love to use it.

We redefine wall panel user experience by adding to the Granite Display our new generation user interface. With the responsive high-resolution display, you will fall in love with it the moment you touch the panel.

- Beautiful and user-friendly interface
- 720 x 720 HD 4.0-inch display
- Blasted finish aluminum frame
- Built-in proximity sensor, temperature sensor, humidity sensor
- **Power supply:** 24V DC
- **Dimensions:** 86 x 86 mm (EU)

S10

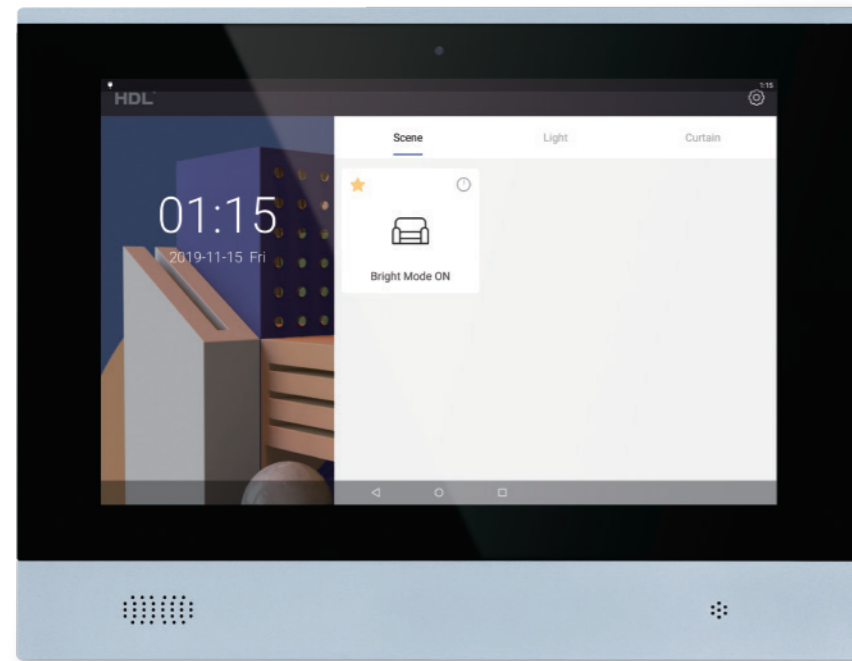

Add credits to interior decoration in a perceptible way.

S10 is a touch panel equipped with a 10.1-inch 800 x 1280P HD display and a dedicated user interface. With the excellent industrial design and UI, a panel of such size will just make your building more beautiful apart from its tech features.



- 10.1-inch 800X1280P display
- 2 MP front facing camera
- Built-in echo-cancellation circuit
- High-sensitivity microphone and low-distortion speaker
- Built-in real-time clock (RTC)
- Built-in proximity sensor, temperature sensor
- **Power supply:** DC 9 ~ 25V
- **Communication:** IP, RS485 (Not Buspro)

S57

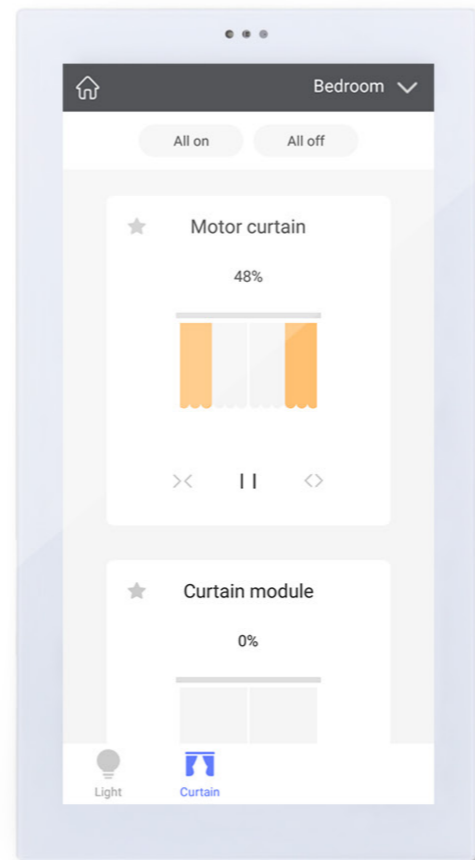
**Quick and full control experience.**

With an 18:9 aspect ratio display embedded in the crystal white panel, S57 stands out among its rivals. The slim body makes it different. You can have quick and full control experience on S57.

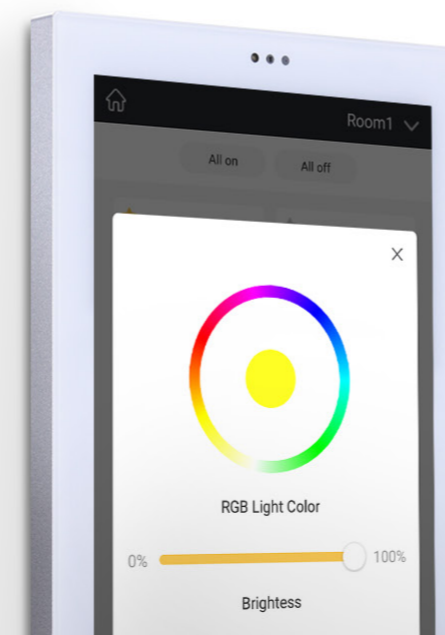
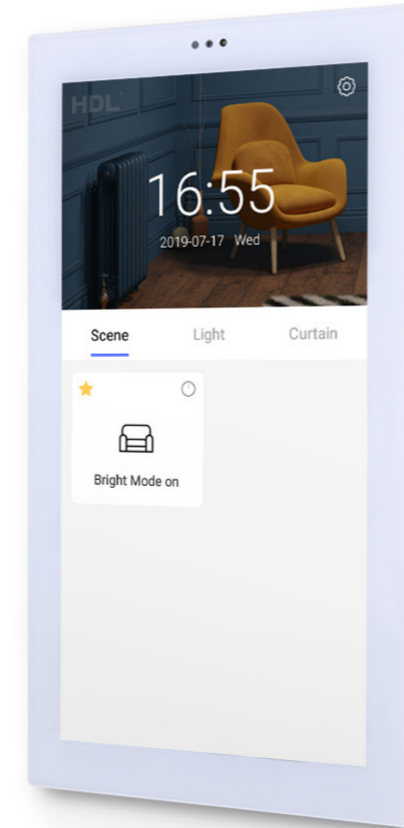

- 5.7-inch 1280 x 640P display with 18:9 aspect ratio
- Built-in proximity sensor, brightness sensor
- Built-in microphone and speaker
- **Power supply:** DC 24V or PoE
- **Communication:** Bluetooth, Wi-Fi, IP

Tile



Premium quality with two materials.

Tile series comes with two versions of different materials: metal and plastic. Each one is able to give you a sense of premium quality, either with the refined sandblasting finishes on the metal one or the skin-like touch feeling on the plastic one.

Color:

Plastic: ■ Ivory White ■ Ash Gray

Metal: ■ Champagne Gold ■ Space Gray

Control everything you need with buttons.

The basic unit of Tile is a keypad or socket panel in EU standard. You can use just one unit if it meets your requirement, or combine multiple units to serve more functionality in a specific area.

- Horizontal



- Vertical

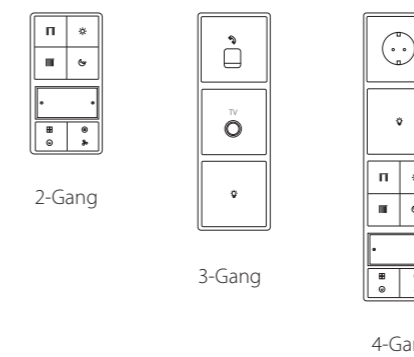

- Supports various types of control targets
- Flexible combinations for required functionality
- RGB icon backlight
- Customizable button icons
- Users are allowed to set the colors of icon backlight
- Available in two materials and four colors



Granite

Granite is a push-button panel with premium metal finish. The RGB indicators, icons and the firm button feedback all together make your control comfortable and intuitive.



Color:

- Arctic silver
- Space gray
- Rose gold

- Premium metal finish
- Natural and comfortable push feedback
- Endures at least 100,000 times of pushes
- **Power supply:** DC 24V
- **Color:** Arctic silver, space gray, rose gold
- **Dimensions:** 86 x 86 mm (EU), 86 x 116.5 mm (US)



Instinctive experience

Most of the time, when we see a metal switch, we push it to control instead of touching it. So, we make it a push-button panel.

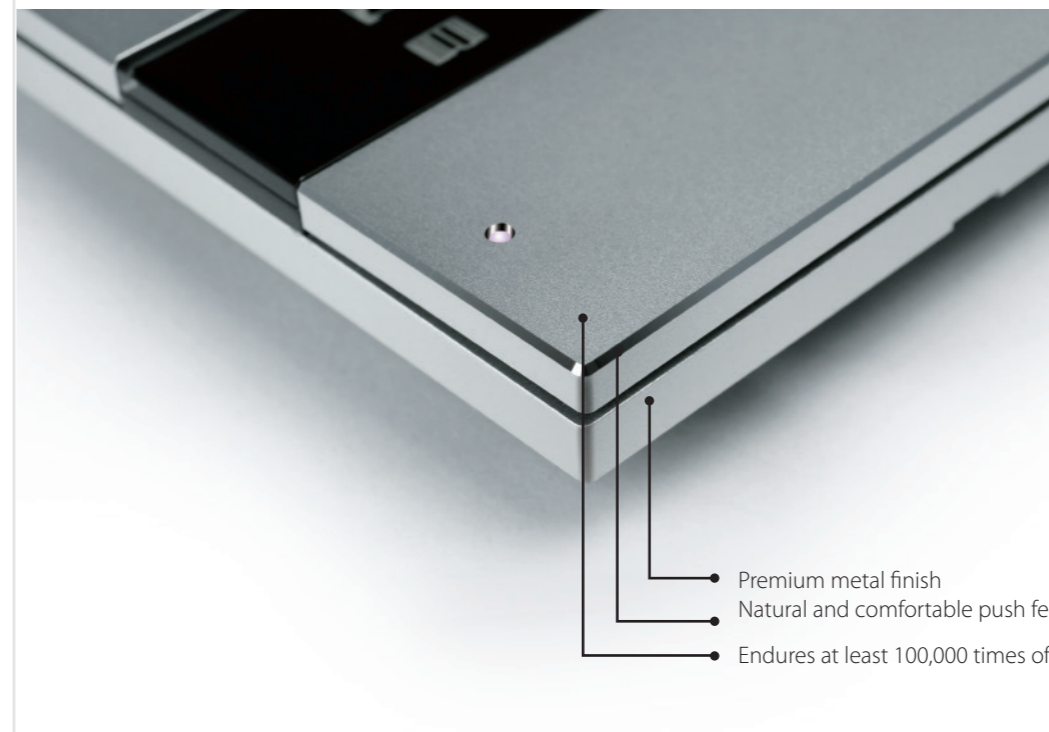

- Premium metal finish
- Natural and comfortable push feedback
- Endures at least 100,000 times of pushes

More intuitive, more beautiful



Prism Pro



One panel for one room

Prism Pro is a touch panel that consists of an elegant metal frame and covered entirely by one piece of glass on the front. With the display showing the control targets and statuses, you can intuitively control lighting, shading, HVAC, music and more functions.

Colors:

Pearl White Night Black



- CNC-cut aluminum frame
- 2.5D glass cover
- 2.4-inch display for intuitive control
- RGB status indicators
- Customizable button icons
- Built-in temperature sensor, proximity sensor
- **Power supply:** DC 24V
- **Colors:** Pearl White, Night Black
- **Dimensions:** 86 x 116.5 mm (US)

Prism Lite

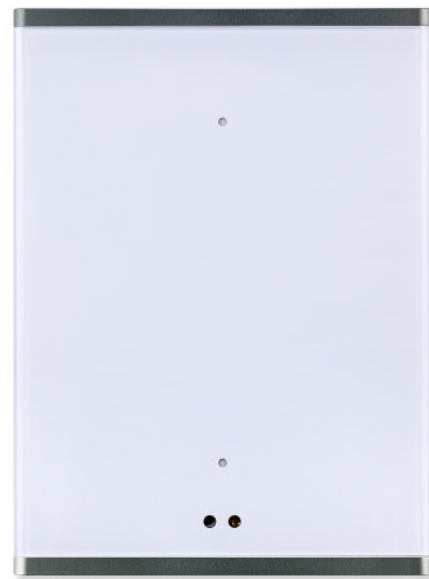

Your choice of ultimate simplicity.

Designed to be premium and simple, Prism Lite can easily merge into your interior deco with its minimal appearance. It would be a perfect choice if you only need to control a few functions.

Colors:

- Pearl White
- Night Black



- CNC-cut aluminum frame
- RGB status indicators
- Customizable button icons

- Built-in temperature sensor, proximity sensor
- **Power supply:** DC 24V
- **Dimensions:** 86 x 86 mm (EU), 86 x 116.5 mm (US)



2.5D Glass Cover

Enviro

What you see is what you control.

Enviro is a touch-control panel equipped with a 4.3-inch display. It allows you to control lighting, curtains, HVAC, music and more functionalities effortlessly on its graphic user interface. What you need to do is just a touch on the screen.

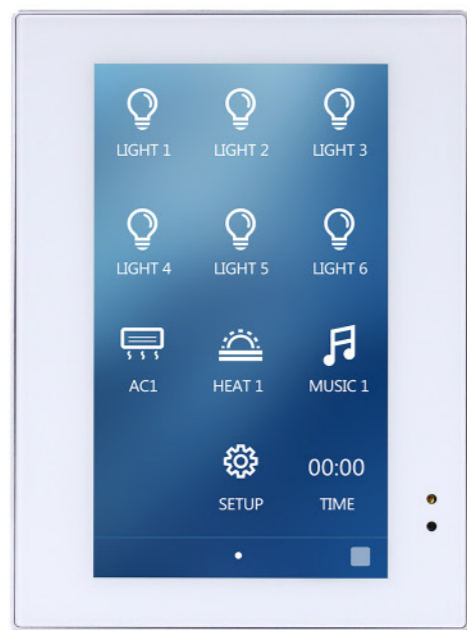

- Color capacitive touch display
- Customizable UI
- Built-in proximity sensor
- Built-in temperature sensor
- Built-in IR receiver
- Built-in real-time clock
- Aluminum frame
- **Power supply:** DC 24V
- Colors: White, black
- **Dimensions:** 86 x 116.5 mm (US)



DLP Touch



Quick and simple touch-control experience.

DLP Touch is designed to offer you a quick and simple touch-control experience. Its face is entirely covered by one piece of glass. With the LCD in the middle, you can have the icons or text customized. Every time you touch the panel, you clearly know what to control. Not a single thought is needed.



- Mono-color LCD
- Customizable icons and captions
- Built-in temperature sensor, proximity sensor, IR receiver
- Aluminum frame
- **Power supply:** DC 24V
- **Dimensions:** 86 x 116.5 mm (US)

DLP**A multi-functional push button keypad.**

If you prefer physical buttons but want to have a display to indicate the control targets, then the DLP panel is here for you.

- Mono-color LCD
- Supports 147 languages
- Customizable icons or captions
- Built-in temperature sensor
- Aluminum frame
- Power supply: DC 24V
- Dimensions: 86 x 86 mm (EU), 86 x 116.5 mm (US)



iTouch



A graceful touch to control.

iTouch is always a great option if you are looking for a beautiful keypad of minimal design. Its body is enclosed by a fine aluminum frame, while the face is a piece of glass with touch buttons. It perfectly matches any interior decoration.

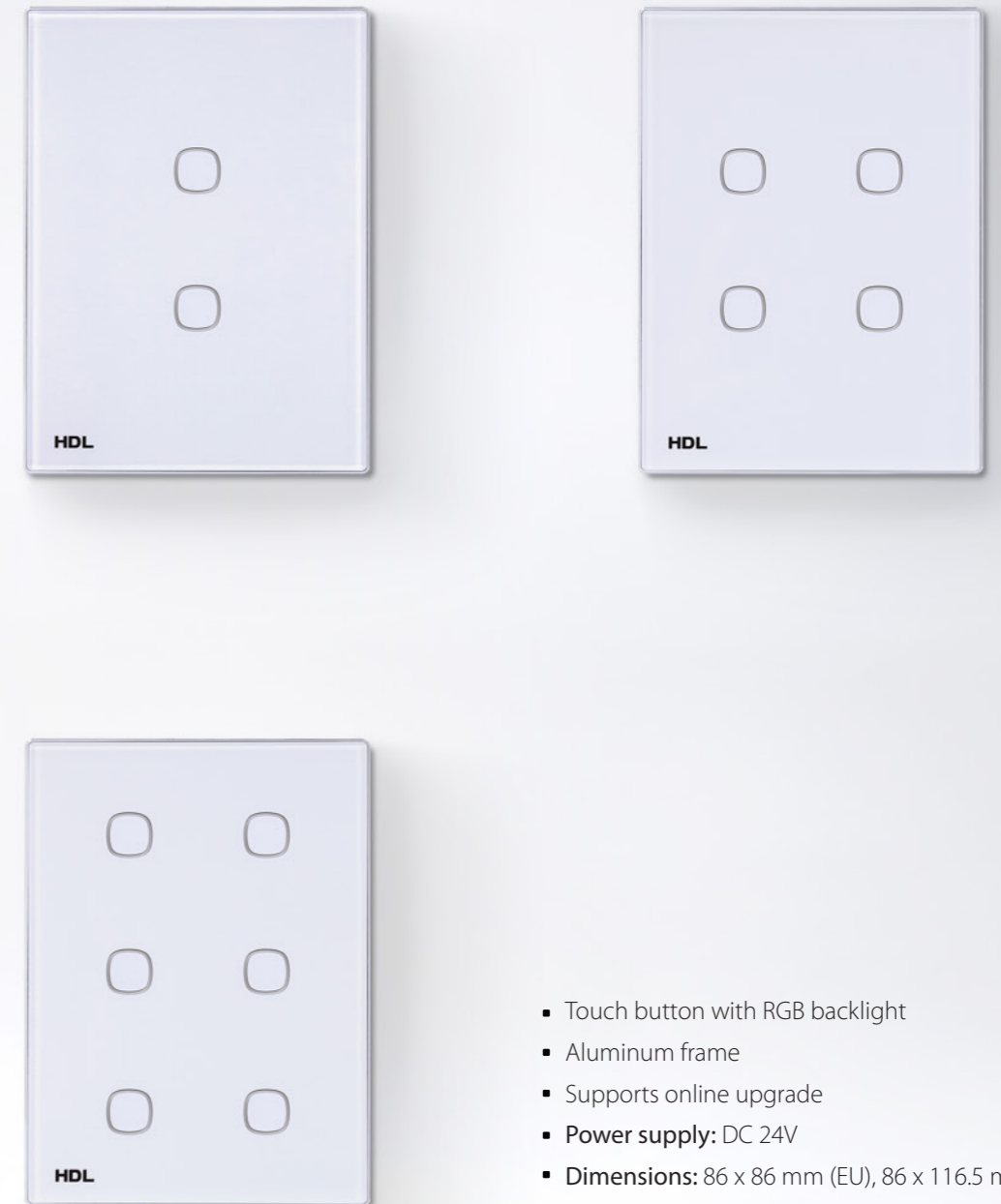

- Touch button with RGB backlight
- Aluminum frame
- Supports online upgrade
- Power supply: DC 24V
- Dimensions: 86 x 86 mm (EU), 86 x 116.5 mm (US)

iFlex

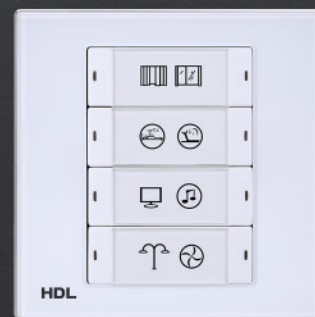

An easy but nice way to have a tag for the button.

What do you think is the easiest way to put an icon or caption on a button? Right, we can draw an icon or write a caption on a piece of paper, and place it on the button. And we call that piece of paper a tag. This IS the idea of HDL iFlex.



- Push button with removable tags
- Aluminum frame
- Power supply: DC 24V
- Dimensions: 86 x 86 mm (EU), 86 x 116.5 mm (US)

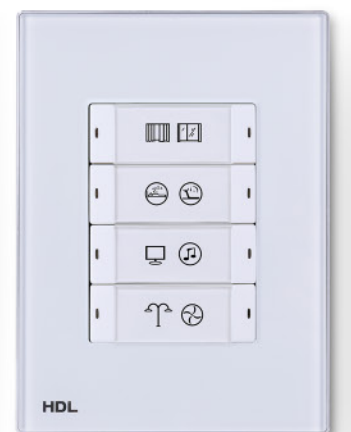

iElegance

Metal is always attractive.

Metal has been a favorable material since the early age of human history. It's some how a signature of reliability. So, we make the iElegance panel with brushed metal finish. It's sturdy and never dies in fashion. You can either match it with vintage style interior decoration or modern one.



- Brushed metal finish
- Power supply: DC 24V



- PRIVACYstatusdisplay
- Visitingfunction
- Support HDL Buspro online upgrading
- Power supply: DC12-30V
- BUS power consumption: 24mA / DC24V
- Dimensions:86×86×22.2(mm)
- Weight: 98g



- Visiting function, time setup
- Do not disturb
- Please clean
- Backlight brightness adjustable
- Support HDL Buspro upgrading
- Power supply: DC12-30V
- BUS power consumption: 25mA / DC24V
- Dimensions:86×86×22.2(mm)
- Weight: 98g



- Control temperature, speed, mode, on/off
- Airconditioningmode: cooling,heating
- Speed: high,low,medium
- Displayindoortemperatureandairconditionstatusetc
- Support HDL Buspro online upgrading
- Power supply: DC12-30V
- BUS power consumption: 25mA / DC24V
- Dimensions:86×86×22.2(mm)
- Weight: 97g



LCD Touch Thermostat

- LCD screen
- **Mode button:** Switch between the modes of cooling, heating, dehumidification, fan speeds, auto.
- **Status display of AC:** Display ON/OFF
- Mode display
- Fan speed display
- Temperature display



- **Power supply:** 40mA / DC24V
- **Working voltage:** 12~30V DC
- **Dimensions:** 86x86x10.5(mm)
- **Weight:** 120g



Notification Stations

A guest's privacy is priceless.

First impressions form lasting memories. That's why the HDL smart guest room experience starts before a guest even enters their room. Choose from two customizable notification stations which show the room number as well as laundry, cleaning, and do not disturb indication.

To make access to the room even easier, the notification stations also features RFID card technology. This means a guest need only swipe their room card to open their door.



- Shows room numbers, indicates the information of Laundry, DND and Clean Room
- 2 dry contacts
- Door bell
- Open the Door by RF card & history record function
- **Power supply:** 12~30V DC
- **Communication:** HDL Buspro
- **Dimensions:** 105×170×35 (mm)



- Shows room numbers, indicates the information of Laundry, DND and Clean Room
- Door bell
- **Power supply:** 12~30V DC
- **Communication:** HDL Buspro
- **Dimensions:** 105×170×35 (mm)



- **Power supply:** 12~30V DC
- **Communication:** HDL Buspro
- **Dimensions:** 86×86×10.5 (mm)

- Optional backlight RGB colors
- Door bell for visitors
- Display requirement of cleaning room
- 1-99 targets can be controlled when user touch the door bell
- 1-49 targets can be controlled when user swipe the card
- The touch sensitivity can be adjusted

Ecomaster Card Switch



Your guest room made energy efficient.

Created to activate or deactivate a room's electrical system, the Ecomaster card range enables hoteliers to dramatically increase their energy efficiency. With the ability to activate different scenes when different cards are inserted, the Ecomaster card switches can personalize how a guest experiences their room.

From automatically activating the lighting, to triggering a welcome message, the card switches deliver a truly efficient customizable environment.



- Master card for energy & power management
- 3 touch buttons, sensitivity can be adjusted
- Button color RGB can be adjusted
- The touch button can be used as the panel button, or work with HDL touch door bell panel, can be displayed DND, Clean, Wait
- Control of mechanical switch can be configured when inserting or taking off the card. Up to 49 targets can be controlled by the switch. Maximum 99 targets can be controlled by other button modes

	MHIC.48	MPTC03.46	MPTC03.48
Power supply	12~30V DC		
Supported card type	MIFARE ONE S50 13.56MHz		
Communication	HDL Buspro		
Dimensions	86x86x20.4 (mm) (EU)	86x86x20.4 (mm) (EU)	116x86x20.4 (mm) (US)



Panel Power Interfaces



MPLPI.46-A

- Install in US standard box
- Supports HDL Buspro/KNX cable
- **Power supply:** DC 24V
- **Dimensions:** 80 x 110.5 x 28.5 (mm)



MPLPI.48-A

- Install in EU standard box
- Supports HDL Buspro/KNX cable
- **Power supply:** DC 24V
- **Dimensions:** 80 x 80 x 28.5 (mm)

Power Interfaces



MPPI.46

- Install in US standard box
- Supports HDL Buspro/KNX cable
- **Power supply:** DC 24V
- **Dimensions:** 83.5 x 114.5 x 26.5 (mm)



MPPI.48

- Install in EU standard box
- Supports HDL Buspro/KNX cable
- **Power supply:** DC 24V
- **Dimensions:** 83.5 x 83.5 x 26.5 (mm)

Power Interfaces for Tile

HDL-MPPI / TILE.48

Tile Series Power Interface works in conjunction with Buspro Tile Series panels and provides working voltage and communication signals to the panel.

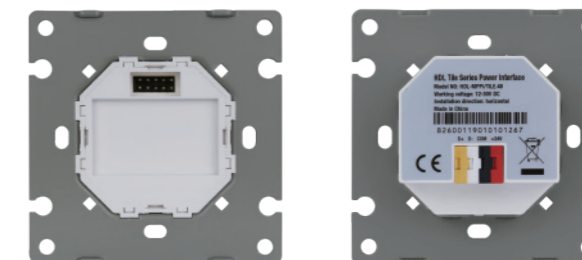

- Install in EU standard box
- Supports HDL Buspro/KNX cable
- **Power supply:** DC 24V
- **Dimensions:** 83.5 x 83.5 x 26.5 (mm)

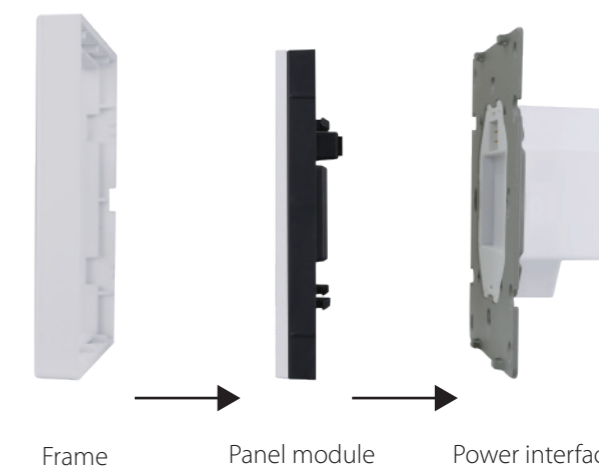

Controllers / Actuators

With a smart system installed, users are allowed to control all connected devices and appliances such as lamps, curtains, air-conditioners, etc. To integrate these devices into a smart system, controllers are required.

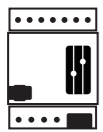

Controllers
/ Actuators

For wired systems, controllers (also known as actuators) are installed in a distribution box in most cases. Power cables of the control targets are inserted in controllers. Then controllers connect with other system devices, say, a wall panel, via data cables.

Relays, dimmers, curtain controllers, floor heating units and logic modules are controllers that often used in building automation projects. In this chapter, we will introduce to you all Buspro controllers.



Dimmers

MOSFET Dimmers



MDT0203.433

MDT04015.433

MDT0601.433

Supported load types: incandescent lamps, halogen lamps, dimmable LED lamps

- **Power supply:** DC 24V
- **Input voltage:** 120V/240V AC (50/60Hz)
- **Consumption:** 25mA/DC24V
- **Output channel (vary from different models):** 2CH/3A, 4CH/5A, 6CH/1A
- **Dimming mode:** Leading edge, trailing edge
- **Dimming curves:** Linear, power 1.5, power 2.0, power 3.0
- **Dimensions:** 216x90x64 (mm)
- 35mm DIN rail installation

Dimmers

TRIAC Dimmers



MD0206.432

MD0403.432

MD0602.432

- **AC power input:** AC110V/AC220V, 50-60Hz
- **Working power:** DC 24V
- **Power consumption:** 28mA/DC24V
- **Maximum output channel current in total:** 10A
- **Dimming curves:** Linear, power 1.5, power 2.0, power 3.0
- **Dimensions:** 144x90x66 (mm)
- 35mm DIN rail installation

	MD0206.432	MD0403.432	MD0602.432
Output channel	2CH/6A	4CH/3A	6CH/2A
Fuse	10A	8A	4A
TRIAC	25A, min 30W	25A, min 30W	16A, min 30W
Weight	602.5g	715g	812.5g

Dimmers

LED Dimmer



MDLED0605.432

- Working Voltage: DC 24V
- Power Consumption: 40mA/DC24V
- LED Output Channel: 6CH/5A
- LED input voltage: DC12~30V
- Dimensions: 144x90x64 (mm)
- 35mm DIN rail installation
- Weight: 351g

Dimmers

DALI Controller



MC64-DALI.431

- Dimensions: 72x90x64 (mm)
- 35mm DIN rail installation
- Net weight: 338g

- Power supply: DC 24V
- Buspro power consumption: 15mA/DC24V
- DALI BUS power: AC220V / AC110V

Dimmers

0 – 10V Dimmer



MRDA0610.432

Suitable for 0-10V dimming control of fluorescent lamps, LED lamps.

- Working Voltage: DC 24V
- Power Consumption: 40mA/DC24V
- LED Output Channel: 6CH/5A
- LED input voltage: 6CH/50mA (Total current is less than 100mA)

- Dimensions: 144x90x64 (mm)
- 35mm DIN rail installation
- Weight: 450g

Dimmers

6CH input & output Module



MSC06.432

The channels input & output module, supports different kinds of output and input signal, it also has 6ch relay outputs.

- Working Voltage: 15~30V DC
- Power Consumption: 80mA/24V DC
- Output (Relay) : 6CH/10A
- Output (signal) : 0~10V DC / 4~20mA

- Dimensions: 144x90x64 (mm)
- 35mm DIN rail installation
- Weight: 375g

Dimmers

High Performance Dimmer

- Input voltage AC100~240V(50/60Hz)
- Power consumption without load Less than 4W
- Output channel 6 channels
- Maximum output current of each channel 10A
- Maximum total output current of channels 60A
- Connection Three-phase four-wire system
- Dimming mode Trailing edge
- Dimming curves Linear, 1.5 exponent, 2.0 exponent, 3.0 exponent



MDH0610A.4D

- Working Voltage: AC100~240V(50/60Hz)
- Power consumption without load: Less than 4W
- Output channel: 6 channels
- Maximum output current of each channel: 10A
- Maximum total output current of channels: 60A
- Dimensions: 400x230x81 (mm)
- Weight: 5.5kg

Dimmers

High Performance Dimmers



MDH0620



MDH0610



MDH1210

- 10-Bit dimming accuracy
- Built-in scene controller
- Fire protection switch
- Remote programing
- Supports incandescent lamps, halogen lamps, dimmable LED lamps

	MDH0620	MDH0610	MDH1210
Output	6 Channels Max. 24A/CH, Total 120A	6 Channels Max. 12A, Total 60A	12 Channels Max. 10A, Total 120A
Dimensions	600 x 290 x 162 (mm)	470 x 290 x 162 (mm)	600 x 290 x 162 (mm)
Output	18.4 kg	15 kg	21.8 kg

Relays

10A Relays



MR0410.431

MR0810.432

MR1210.433

- Power supply: DC 24V
- Working voltage: 15~30V DC Class 2
- Dynamic power consumption: 40mA/DC 24V
- Max current in each channel: 10A
- 35mm DIN rail installation

	MR0410.431	MR0810.432	MR1210.433
Output	4 Channels	8 Channels	12 Channels
Separate Zones	4	8	12
Scenes / zone	8 scenes, 60min running time	16 scenes, 60min running time	12 scenes, 60min running time
Dimensions	72 x 90 x 64 (mm)	144 x 90 x 64 (mm)	216x 90 x 64 (mm)
Weight	252g	361g	645.5g

Relays

16A Relays



MR0416.431

MR0816.432

MR1216.433

- Power supply: DC 24V
- Working voltage: 24~30V DC Class 2
- Dynamic power consumption: 35mA/DC 24V
- Max current in each channel: 16A
- 35mm DIN rail installation

	MR0416.431	MR0816.432	MR1216.433
Output	4 Channels	8 Channels	12 Channels
Separate Zones	4	8	12
Scenes / zone	8 scenes, 60min running time	16 scenes, 60min running time	12 scenes, 60min running time
Dimensions	72 x 90 x 64 (mm)	144 x 90 x 64 (mm)	216x 90 x 64 (mm)
Weight	248g	567g	814.3g

Relays

12CH 20A Relays



MR1220C.433

- 12-channel relay output unit
 - Scene control and sequence control
 - Up to 12 separate zones
 - 12 scenes for each zone, scene running time up to 60 minutes
 - 2 sequences for each zone, up to 12 steps for each sequence
 - Light protection delay for each channel (0-60 minutes)
 - Mass turn-on delay for each channel(0-25 seconds)
 - Manual switch for each channel
 - Stair lamp function of the channel settable
- **Power supply:** 24~30V DC
 - **Buspro power consumption:** 38mA/24V DC
 - **Signal interface:** HDL Buspro
 - **Dimensions:** 216x90x64 (mm)
 - **Net weight:** 800g
 - 35mm DIN rail installation

DMX Modules

48 CH DMX Scene Controller



MC48IP-DMX.431

- **Load types:** RGB lights, LED strips, other DMX devices
 - Supports ArtNet / HDL-NET DMX protocol
 - 48 control channels, Max. 48 separate zones
 - 99 different scenes can be set for each zone
 - 99 performance sequences
 - **Running mode of sequence:** forwards, backwards, forwards & backwards, random
 - DMX512 (1990 version)
- **Power supply:** DC 24V
 - **Buspro power consumption:** 40mA/DC24V
 - **Signal interface:** HDL Buspro, RJ45
 - **Dimensions:** 72x90x64 (mm)
 - **Net weight:** 142g
 - 35mm DIN rail installation

DMX Modules

512 CH DMX Scene Controller



MD512-DMX.232

- **Load types:** RGB lights, LED strips, other DMX devices
- Can set 500 scenes with running time from 0.1s to 60m
- HDL-NET DMX output
- 99 performance sequences, 255 steps for each sequence
- Running mode of sequence: forwards, backwards, forwards & backwards, random
- DMX512 (1990 version)
- Supports soft reset with power on

- **Power supply:** DC 24V
- **Buspro power consumption:** 200mA/DC 24V
- **HMI:** 128x64 raster graphic LCD 6 soft-touch buttons
- **Dimensions:** 144x90x64 (mm)
- **Weight:** 429g
- 35mm DIN rail installation



DMX Modules

Connection Topology

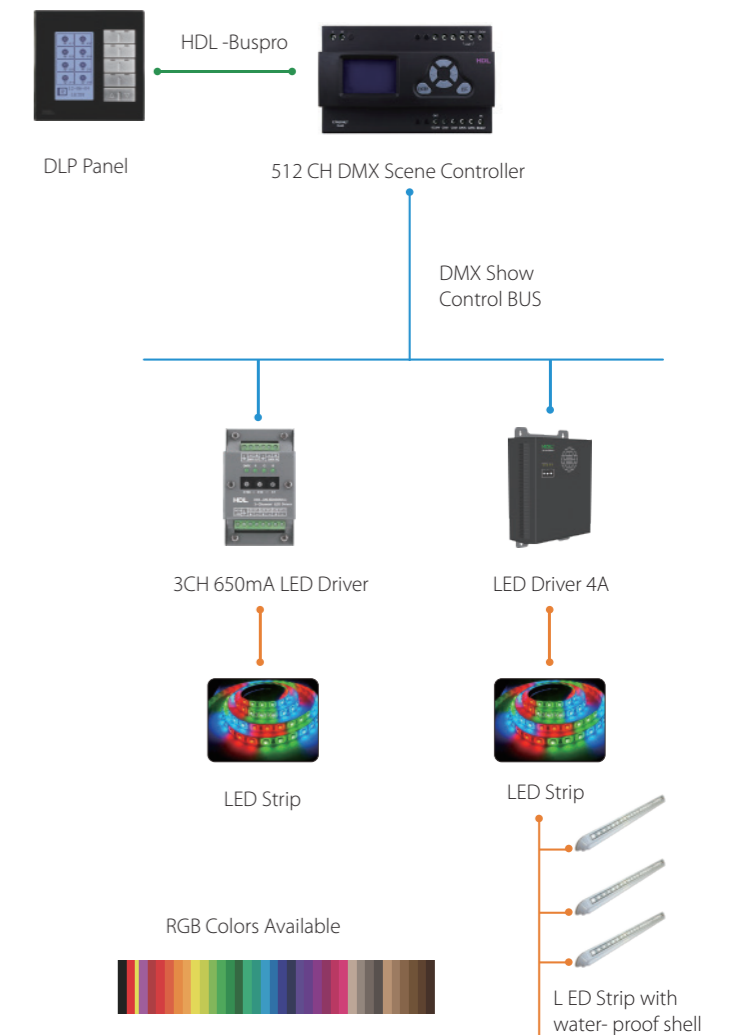

Change the colors of your lights to give an out standing first impression to your customers or guest.

IR Emitters

IR Transmitter with Current Detection

- Supports up to 200 infrared codes for universal appliances, such as air conditioning, TV, set-top box, DVD, etc.
- More infrared codes accessible from HDL IR code library and IR Learner
- Current detection



MIR01F.20

- Buspro power supply: DC 24V
- Buspro power consumption: 15mA/24V DC
- IR codes store: Maximum 200 IR codes
- Sending carrier wave frequency: 38KHz
- Distance for IR Control: 6m
- Dimensions: 45×40×13(mm)
- Net weight: 58g

IR Emitters

4 CH IR Emitter with Current Detection / Infrared Code Learner

- Built-in 4 IR emitters
- Supports up to 100 infrared codes for universal appliances, such as air conditioning, TV, set-top box, DVD, etc.
- More infrared codes accessible from HDL IR code library and IR Learner
- Sequence control
- Current detection



MIRC04.40

- Buspro power supply: DC 24V
- Buspro power consumption: 30mA/24V DC
- Sending carrier wave frequency: 38KHz
- IR control distance: 5m
- Dimensions: 45×45×16 (mm)
- Net weight: 58g



MIR01L.01

- USB port
- No drivers required
- IR code learning
- IR code emitting testing
- LED indication
- Range of carrier wave frequency: 38KHz±20%
- USB: 2.0, doesn't require driver
- Dimensions: 98×70×38(mm)
- Weight: 180g

Shading Control

Curtain Motor

With the HDL curtain motors, your curtains can run the full way to close and open while can be stopped at any position a Stop button. Or you can select a percentage to let them stop at a preset position.



MWM65B.20

- **Control Mode:** close, open, stop, percentage
Pull to activate motor
- Supports manual control when power off
- Quiet running
- **Buspro power supply:** DC 24V
- **Rated voltage:** 12-30V DC

- **Motor rotate speed:** 95rpm
- **Rated torque:** 1.2Nm
- **Terminal wire diameter:** 0.6-0.8mm
- **Dimensions:** 283×71×50.6(mm)
- **Net weight:** 996g

Dry Contact Curtain Motor 220V AC

- **Power:** 100-240V AC
- **Motor rotate speed:** 118rpm
- **Rated input voltage:**
AC 100-240V (50/60Hz)
- **Motor torque:** 1.0N.m
- Ultra-quiet at 35dB
- **Rated input current:** 1.2A
- **IP rating:** IP41



Product code: 230

- Anti-sinking and waterproof design
- Quiet, DC motor, unique compact and neat motor design
- Full automatic setting of the limits
- Built-in radio receiver, with dry contact port
- Supports Open, Stop, Close and Percentage control

Dry Contact Curtain Motor with Adapter / Curtain Remote Controller



YR2112/YR2116



Product code: 210

- **Power:** External 24V DC
- **Rated input voltage:** 24V DC
- **Rated input current:** 1.3A
- **Motor rotate speed:** 85rpm
- **Motor torque:** 1.2N.m
- Ultra-quiet at 35dB
- **IP rating:** IP4 1

Shading Control

Tubular Blind Motor



- High-accuracy position limit
- Internal structure is sealed and lubricated for low noise and vibration
- Overheat and overload protection
- Flame-retardant material for low fire risk
- Supports open, stop, close and percentage control
- Supports remote control
- Ultra-quiet at 35dB
- The motor and aluminum tube are assembled together by default



MVSM35B.12

- Working voltage: 12-30V DC
- Working current: 6mA / 24V DC
- Rated input voltage: AC 220-240V (50Hz)
- Rated input current: 0.9A
- Motor torque: 3N.m
- Motor rotate speed: 22rpm
- Dimension: $\Phi 35 \times 528$ (mm)
- Weight: 1224g (Motor)



Blinds Motor 220V AC is applicable with blinds, Roman blind, venetian blind, etc. With HDL blind motors, you can easily control your blinds with a smart phone, wall panel or a remote.



Buspro Curtain Motor Track

Track is made of aluminum alloy with a wall thickness of 2mm and an ivory white lubricating coating. Plastic parts are POM material and metal parts are 304 stainless steel. Support segmented connection. Maximum length: 6meters.



Shading Control

2CH Curtain Controller



MW02.431

- Working voltage: 15~30V DC Class 2
- Bus power consumption: 35mA/24V DC
- Maximum current per CH: 5A
- Relay life time: >60000 (Resistance load)
- Supported AC motor type: Single-phase capacitor
- Dimensions: 72x90x64 (mm)
- Net weight: 250g
- 35mm DIN Rail installation

Climate Controllers

6CH Floor Heating Module / 4CH Electric Fan Controller



MFH06.432



MFAN04.432

- Power supply: DC 24V
- Dynamic power consumption: 150mA / DC 24V
- Output channels: 6
- DC 0-10V output current: 10mA
- Relay output current: 1A
- Relay unit life time: 5,000,000 times
- 35mm DIN Rail installation

- Power supply: DC 24V
- Power consumption: 81mA/24V DC
- Input voltage: AC100-240V (50/60Hz)
- Relay unit life time: >60000 actuations
- 35mm DIN Rail installation

	MFH06.432	MFAN04.432
Dimensions	144x90x64 (mm)	144x90x64 (mm)
Weight	285g	341g



Climate Controllers

Air Conditioning Control Module



MAC01.431

- Power supply: 15~30V DC Class 2
- Buspro power consumption: 95mA/24V DC
- Maximum current per channel: 5A
- Relay life time: >60000 (Resistance load)
- Dimensions: 72x90x64 (mm)
- 35mm DIN Rail installation
- Net weight: 241g

Logic Module



MCLog.431

- Built-in 960 logical blocks
- Supports various input conditions such as scene status, channel status, date, week, time, etc.
- Support 4 logic relations: AND, OR, NAND, NOR.
- Built-in real-time clock
- Working voltage: 15~30V DC
- Buspro power consumption: 15mA /DC 24V
- Dimensions: 72x90x64 (mm)
- 35mm DIN Rail installation
- Net weight: 122g

Security Module



MSM.431

- Designed to send alarms, notifications and phone calls when the security system is activated.
- Multiple alarm modes: Intrusion, Fire, Temperature, SOS, etc.
- Multiple security modes: Away, Holiday, Night, Day, Timing, etc.
- Supports alarm record logging and viewing
- Power supply: DC 24V
- Buspro power consumption: 15mA / DC 24V
- Dimensions: 72x90x64 (mm)
- 35mm DIN Rail installation
- Net weight: 121g

Hotel Series

RCU



MHRUCU.433

- Built-in gateway with IP interface
- CH 1 to 13: 5A relay output
- CH 14 to 17: 10A replay output
- CH 18 to 21: 1A dimmer output
- Power supply: DC 24V
- **Static power consumption:** 300mA/24V DC
- **Relay output:** 5A/10A
- **Dimension:** 216x90x56 (mm)
- 35mm DIN Rail installation
- **Net weight:** 725g

Hotel Series

Room Control Host



MHC48IP.431

- Works with other HDL hotel modules as a gateway
- Manages up to 48 channels
- **Power supply:** DC 24V
- **Buspro power consumption:** 30mA/24V DC
- **Dimensions:** 72x90x64 (mm)
- 35mm DIN Rail installation
- **Net weight:** 143g



MHC48IP/D.431

- Works with other HDL hotel modules as a gateway
- Manages up to 48 channels
- **Power supply:** DC 24V
- **Buspro power consumption:** 600mA/DC24V
- **Dimensions:** 72x90x67.5 (mm)
- 35mm DIN Rail installation
- **Net weight:** 130g

Hotel Series

22CH Mix Controller / 51 Dry Contact Module

- 20 channels of relay output
- 2 channels of MOSFET dimmer output
- Easy configuration



MHMIX22.232

- Power supply: DC 24V
- Static power consumption: 15~30V DC
- Dynamic power consumption: 180mA/24V DC
- MOS tube voltage input: AC100~240V(50/60Hz)
- Dimensions: 144mm×90mm×64mm
- Net weight: 572g



MHS51.231

- Power supply: 24V DC
- Working current: 280mA/24V DC
- Output current: Max. 8mA/CH
- 35mm DIN rail installation
- Dimensions: 72mm×90mm×67.5mm
- Net weight: 387g

Hotel Series

I/O Module

- 12 channel outputs for dimming, relay, and curtain control 19 channel inputs for dry contact and doorbell control
- Compatible with multiple load types such as incandescent lighting, halogen lighting, LED lighting, etc.



MHIOU-II.432

- Power supply: DC 24V
- Static power consumption: 30mA/DC24V
- Dynamic power consumption: 185mA/24V DC
- Dimensions : 144×90×56 (mm)
- 35mm DIN Rail installation
- Net weight: 375g

Hotel Series

4CH 0.5A Universal Dimmer
/ 5CH High Power Relay



MHD04A.231

- Power supply: DC 24V
- Working voltage: 15~30V DC
- Input voltage: AC100-240V(50/60Hz)
- Dimensions: 72x90x64 (mm)
- 35mm DIN Rail installation
- Net weight: 234g

Output channel

Enables the switch control between four channels of 0-10V dimming output and four channels of MOSFET dimming output.



MHR05L.231

- Power supply: DC 24V
- Working voltage: 15~30V DC
- Emergency channel: 2CH/5A (AC220V 50Hz) Emergency relay (CH1~2)
- Dimensions: 72x90x64 (mm)
- 35mm DIN Rail installation
- Net weight: 418g

Output channel

2CH/10A (AC100-240V 50/60Hz) Relay (CH3, CH5)
1CH/5A (AC100-240V 50/60Hz) Relay (CH4)

Hotel Series

10CH / 20CH Mix Controller



MHD02R18U.232

- Power supply: DC 24V
- Input voltage: AC100-240V(50/60Hz)
- Relay output: 5A/10A resistive loads
- Dimming output: 1A silicon-controlledrectifier outputs
- 35mm DIN rail installation
- Dimensions: 144x90x64(mm)
- Net weight: 564g



MHMIX10.231

- Power supply: DC 24V
- Input voltage: AC100-240V (50/60Hz)
- Dimming mode: MOSFET trailing edge
- 35mm DIN rail installation
- Dimensions: 72mmx90mmx64mm
- Net weight: 418g

Output channel

6CH/5A(AC100-240V 50/60Hz) Relay (CH1~4, CH6~7)
2CH/10A(AC100-240V 50/60Hz) Relay (CH5, CH8)
2CH/0.5A (AC100-240V 50/60Hz) MOSFET dimming (CH9~10)

Sensors

A smart system can do a lot of interesting and useful things automatically.

It can close curtains or adjust the brightness of a lamp to keep a room at a constant lighting level. It can turn on the air-conditioner when a person sits in a meeting room for over 60 seconds, and turns it off when everybody leaves the room. It can shut down the heating system when you left the window open. It can trigger the alarm system if a thief breaks in your home when you are away for vacation...

But how does the system read the status of the environment? How does it learn the changes of a certain subject? It's the sensors.



Sensors

Sensors are like our eyes, ears, nose that help us acquire the information of the external world. Sensors detect what happens in the environment and translate the information into the language (or protocol) spoken by the system. The system receives this information and will see what it has to do in accordance with its logic settings.

If we categorize sensors according to the technology they use, there can be ultrasonic sensors, Doppler sensors, PIR sensors, light sensors and more. And sometimes, we refer them as what they are used for, such as motion sensors, which are used for detecting human motions. But either a PIR sensor, doppler sensor or ultrasonic sensor can be used for motion detecting. It's up to you, the engineer, to decide and define how a sensor works in a solution.



Outdoor Doppler Sensor



MSOUT.4W

- Light sensor
- Temperature sensor
- Humidity sensor
- Motion sensor
- Dry contact
- Universal switch

- Power supply: DC 24V
- Power consumption: 31mA / DC 24V
- Temperature detection range: -40°C~60°C
- Illumination detection range: 0~15000LUX
- Humidity detection range: 20~95%RH
- Microwave detection range: Φ30m (Installation height: 3m)
- Dimensions: 126×78×42 (mm)
- Weight: 360g

Temperature & Humidity Sensor / Light & Air Quality Sensor



MASTH.2C



MASLA.2C

- Built-in temperature sensor, humidity sensor, light sensor
- Buspro power consumption: 25mA / DC 24V
- Range of temperature sensor: -20 °C ~+60 °C
- Range of LUX sensor: 0~5000Lux
- Range of humidity sensor: 20%~95%
- Built-in light sensor, air quality sensor
- Buspro power consumption: 25mA / DC 24V
- Illumination detection rang: 0-5000 Lux
- Communication: HDL Buspro
- Buspro terminal: CAT5 or CAT5e

	MASTH.2C	MASLA.2C
Power supply	DC 24V	DC 24V
Dimensions	Φ80×32(mm)	Φ80×32(mm)
Net weight	92.5g	86.5g

Ultrasonic Sensor



MSPU03.4C

- Built-in ultrasonic sensor, light sensor
- Built-in logic block, universal switch
- Power supply: DC 24V
- Buspro power consumption: 30mA / DC 24V
- Ultrasonic sensor range in diameter: 6m (Installation Height: 3m)
- Range for LUX sensor: 0-500lux
- Dimensions: Ø63x38(mm)
- Net weight: 91g

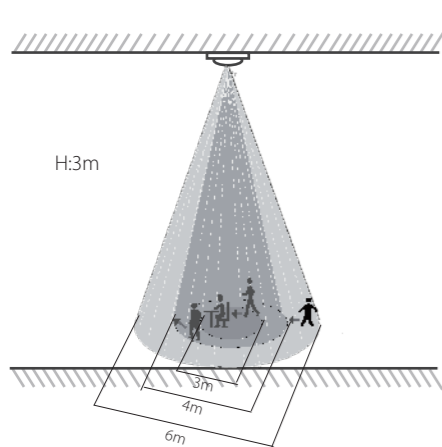

Detection range

- Walking towards with pause
- Walking across
- Sitting / Walking towards constantly

Detection Range (At 25°C)

Mounting height	Sitting / walking towards constantly	Walking across	Walking towards with pause
3m	3m	4m	6m

PIR & Light Sensor



MSP02.4C

- Built-in ultrasonic sensor, light sensor
- Built-in logic block, universal switch
- Power supply: DC 24V
- Buspro power consumption: 30mA / DC 24V
- Ultrasonic sensor range in diameter: 6m (Installation Height: 3m)
- Range for LUX sensor: 0-500lux
- Dimensions: Ø63x38(mm)
- Net weight: 91g

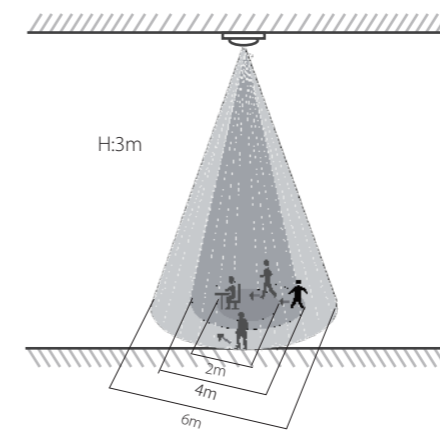

Detection range

- Walking across
- Walking towards with pause
- Sitting / Walking towards constantly

Detection Range (At 25°C)

Mounting height	Sitting / walking towards constantly	Walking towards with pause	Walking across
3m	2m	4m	6m

Surface Mount Indoor Microwave sensor



MSW01.4C

- Power supply: DC 24V
- Buspro power consumption: 32mA / DC 24V
- Range for LUX sensor: 0-500lux
Dimensions: $\Phi 63 \times 38$ (mm)
- Net weight: 90.5g

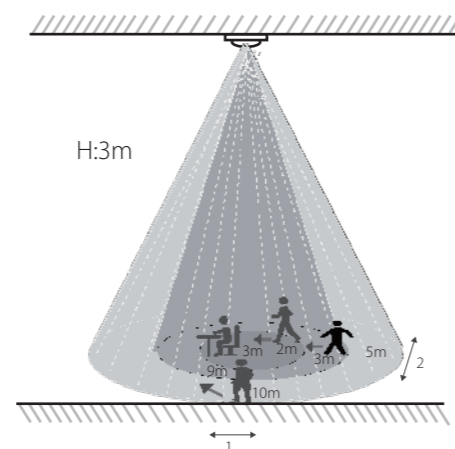

Detection Range(At 21 °C)

Mounting height	Directions	Sitting	Walking towards	Walking across
3m	1. major axis direction	3m	9m	10m
	2. minor axis direction	2m	3m	5m

7 in 1 Sensor



MSP07M.4C

- Built-in PIR sensor, temperature sensor, light sensor
- Two dry contacts
- Two universal switches
- Power supply: DC 24V
- Buspro power consumption: 5mA / DC 24V
- Detection diameter: $\Phi 8$ m (Installation height:3m)
- Temperature detection range: $-20\text{ C} \sim 60\text{ C}$
- Illumination detection range: 0~500Lux
- Dimensions: $\Phi 84 \text{mm} \times 37.5 \text{mm}$
- Net weight: 55.4g

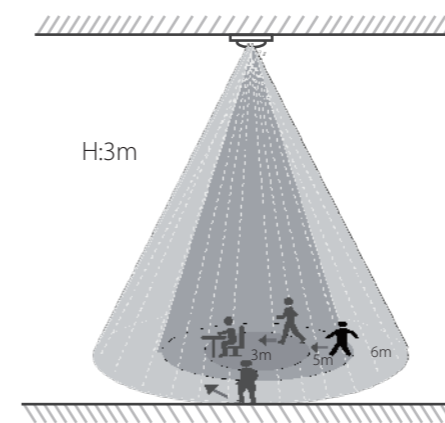

Detection Range(At 25 °C)

Mounting height	Sitting / Walking towards constantly	Walking towards with pause	Walking across
3m	3m	5m	6m

- Walking across
- Walking towards with pause
- Sitting / Walking towards constantly

8 in 1 Sensor



MSP07M.4C

- Built-in PIR sensor, light sensor, temperature sensor, IR emitter
- Two dry contacts
- Two universal switches
- Power supply: DC 24V
- Buspro power consumption: 30mA / DC 24V
- IR transmit frequency: 38KHz
- Detection diameter: Φ 8m (Installation height:3m)
- IR emission distance: 4m
- Illumination detection range: 0~500Lux
- Dimensions: Φ 84mm x37.5mm
- Net weight: 55.4g

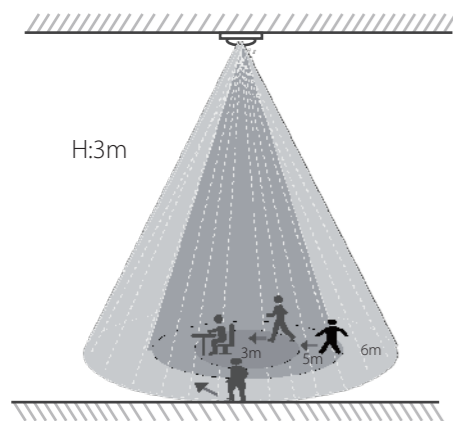

- Walking across
- Walking towards with pause
- Sitting / Walking towards constantly

Detection Range(At 25 °C)

Mounting height	Sitting / Walking towards constantly	Walking towards with pause	Walking across
3m	3m	5m	6m

12 in 1 Sensor



MS12.2C

- Built-in PIR sensor, light sensor, ultrasonic sensor, temperature sensor
- Built-in IR receiver, IR emitter
- Two dry contacts
- Two universal switches
- Two relay channels
- Power supply: DC 24V
- Static power consumption: 40mA / DC 24V
- Dynamic power consumption: 90mA / DC 24V
- IR transmit frequency: 38KHz
- IR emission distance: 4m
- Illumination detection range: 0-5000Lux
- PIR sensing range in diameter: 6m (install height-3m)
- Ultrasonic sensor in diameter: 8m
- Dimensions: Φ 110mm x35mm
- Net weight: 207g

Ultrasonic Detection Range

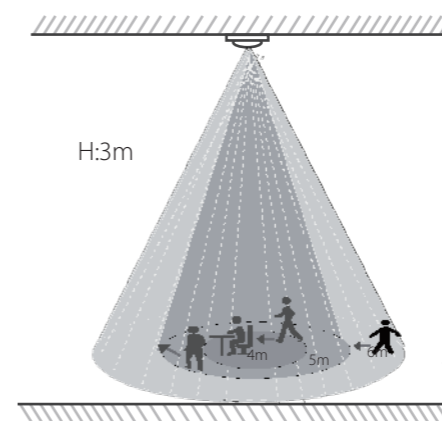

- Walking towards with pause
- Walking across
- Sitting / Walking towards constantly

Ultrasonic Detection Range(At 25 °C)

Mounting height	Sitting / Walking towards constantly	Walking across	Walking towards with pause
3m	4m	5m	6m

PIR Detection Range

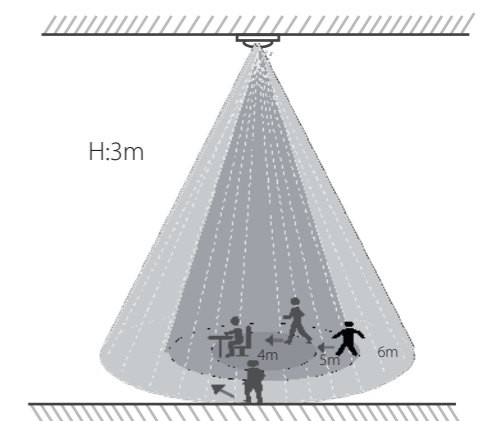

- Walking across
- Walking towards with pause
- Sitting / Walking towards constantly

PIR Detection Range(At 25 °C)

Mounting height	Sitting / Walking towards constantly	Walking towards with pause	Walking across
3m	4m	5m	6m

Gateways

A gateway is the translator between different communication protocols.

It is required when a system or device talks to another one that speaks a different language. For example, a Buspro IP Gateway should be in place if we want to connect HDL Buspro with the Internet so that a user would be able to access the system with a mobile phone. In this case, the IP Gateway translates Buspro into IP spoken by the Internet.

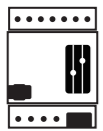

Gateways

Most of the time, gateways are used for integrating different technologies into one system or project. We can see RS232 gateways for connecting smart door locks, KNX gateways for integrating with KNX system, HVAC gateways for adding centralized air-conditioning systems, etc.

But sometimes, we may not have a proper gateway to translate the signal from a certain device. And we use a dry contact module to connect with that device. So, here we regard dry contact modules as some kind of universal gateways and list them in this chapter.

Take a look at this chapter and find the gateway you need for HDL projects.



RS232/RS485 Gateway



MRS232U.431

- Power supply: DC 24V
- Buspro power consumption: 15mA/DC24V
- Communication: HDL Buspro/RS232/RS485
- Dimensions: 72x90x66 (mm)
- Weight: 310g

Buspro/KNX Gateway Buspro IP Gateway



MCEIB.231

- HDL Buspro input voltage: 15~30V DC
- HDL Buspro input current: 5mA/24V DC
- KNX/EIB input voltage: 21~30V DC
- KNX/EIB input current: 6mA/30V DC
- Communication: HDL Buspro, KNX/EIB
- Dimensions: 72x90x64 (mm)
- 35mm DIN Rail installation
- Net weight: 174g



MBUS01IP.431

- Power supply: DC 24V
- Buspro power consumption: 40mA/24V DC
- Signal interface: HDL Buspro, RJ45
- Dimensions: 72x90x64 (mm)
- 35mm DIN Rail installation
- Net weight: 124g

Intellicenter Gateway



MSERVER/D.20

- Working voltage: 12~30VDC
- Power consumption: 2.5W max
- Communication: RJ45, HDL Buspro, KNX Bus
- Operation system: iRidium Server software
- Dimension: 72×95×61(mm)
- 35mm DIN Rail installation
- Net weight: 250g

24CH Dry Contact Module



MS24.232

- 24 dry contact channels
- Power supply: DC 24V
- Buspro power consumption: 12mA/24V DC
- Dimensions: 144×90×64(mm)
- 35mm DIN Rail installation
- Net weight: 373g

4/8CH Dry Contact Module



MSD04T.40

- 4 dry contact channels
- Power supply: DC 24V
- Buspro power consumption: 10mA / DC 24V
- Dimensions: 45×45×16(mm)
- Net weight: 57g



MSD08.40

- 24 dry contact channels
- Power supply: DC 24V
- Buspro power consumption: 15mA/24V DC
- Dimensions: 45×45×16(mm)
- Net weight: 45g

Audio Devices

If you had a chance visiting an automated home, you possibly heard the greeting words of a female voice when you open the front door of it. That is the voice prompts from the system: when the user unlocks the door, the system plays the greeting words. And this feature will need audio devices installed.



Audio
Devices

Music players and speakers are the audio devices often used in automation projects. You can simply use them for listening to music, or playing the voice prompts.



HomePlay



MZBOX-A50B.30

- **Power Amplifier Rated output:** 32W+32W (8Ω/ohms,1kHz, 0.7%)
- **Speaker Impedance:** 4-32Ω
- **Dynamic Range:** >87dB
- **S/N Ratio:** >88 dB
- **Stereo Separation:** >81.5dB (1KHz)
- **Frequency Response:** 20Hz to 20KHz (±3dB)
- **Power supply:** AC100-240V, 60/50Hz/DC
- **Input:** DC24V @ 3.3A
- **Dimensions:** (H x W x D)144mm (184mm with antenna) x112mmx31mm
- **Weight:** 1.3Kg

Multi-platform Compatibility

At HDL we know that everyone has their preferred method of audio storage. That's why we've given HomePlay truemulti-platform compatibility.

With Bluetooth and WiFi connectivity, a LAN port, and a USB port HomePlay can directly connect to your audio library. Seamlessly controlled through the HDL On app, you can stream all of your favorite tracks to any room to create your ideal audioscape.



Better Together

Quickly and intuitively browse through the entirety of your music collection.

With the ability to directly play files from network attached storage devices (NAS), an onboard Micro SD card slot, an onboard USB port, and your connected iOS & Android devices, total audio management has never been easier.

This coupled with native MP3, WMA, AAC, AAC+, ALAC, FLAC, APE, and WAV format support makes all your music just a tap or click away.



Infrastructure Devices / Accessories

An infrastructure device is something that you have to use in your project regardless whatever features or functions to be achieved. For instance, a power supply module is always needed. But the it has nothing to do with lighting, shading or any other functionality.

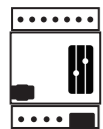

Infrastructure Devices
/ Accessories

In this chapter, you will pick up what you must need in an HDL project.



750mA/1200mA Power Supply Module



MSP750.431

- Input voltage: AC100-240V(50/60Hz)
- Output current: 750mA
- Output voltage: 24V DC
- Output ripple wave: Less than 150mV
- Dimensions: 72×90×64 (mm)
- 35mm DIN Rail installation
- Net weight: 188g



MSP1200.431

- Input voltage: AC100-240V(50/60Hz)
- Output current: 1200mA
- Output voltage: 24V DC
- Output ripple wave: Less than 150mV
- Dimensions: 72×90×64 (mm)
- 35mm DIN Rail installation
- Net weight: 188g

2.4A Power Supply Module



MSP2400.232

- Input voltage: AC100-240V(50/60Hz)
- Output current: 2400mA
- Output voltage: 24V DC
- Dimensions: 144×90×64 (mm)
- 35mm DIN Rail installation
- Net weight: 387g

TRIAC Constant Current Module

- Power supply: 0~240V AC
- Frequency: 50~60Hz
- Load channel constant current: 22mA
- Dimensions: 37.4×26.7×22.6(mm)
- Weight: 73g

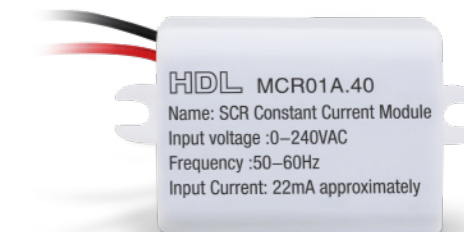

MCR01A.40

MOSFET Power Amplifier



MDB0210.433

- AC power input: AC 110/230V
- Output channel: 2CH,10A/CH
- Maximum output channel current in total: 16A
- Dimensions: 216×90×66 (mm)
- 35mm DIN Rail installation
- Weight: 540.5g

6 Ports Switch / 6 CH Connector



MBR06.431

- Working voltage: 12~30V DC
- Power consumption: 15mA / DC 24V
- 6 Buspro ports
- Devices for each port: 0-63
- Communication: HDL Buspro
- Dimensions: 72 × 90 × 64 (mm)
- 35mm DIN Rail installation
- Net weight: 139g



MBC06.431

- 6 Buspro ports
- Dimensions: 72×90×64 (mm)
- 35mm DIN Rail installation
- Net weight: 114.5g

LED Driver



MLED03650MA

- Input power: 12~30V DC
- Input signal: DMX512
- Power consumption without load: <2W
- Output channel: 3 channels
- Max Current of each channel: 650mA
- Dimensions: 96×58.5×22.5(mm)
- Net weight: 150g

HDL Buspro Cable

FastFix Cable



MCL04(08/12/16)P.40



Recommended connection: hand in hand

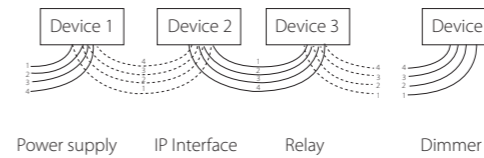

- 4 core shielded cable: red, black, white, yellow.
- Strong signal transmission capability.
- Strong anti-jamming capability.
- Convenient for wiring connection.

HDL FastFix cable	X (mm)
HDL-MCL04P.40	138
HDL-MCL08P.40	206

HDL FastFix cable	X (mm)
HDL-MCL12P.40	286
HDL-MCL16P.40	350



BUS-KNX-EIB

You are suggested to connect HDL Buspro devices with our dedicated bus cable. Apart from the fast-connect cables with preset ports, you can also purchase the cable according to the length you need. It is available in two versions: shielded and unshielded.

buspro

WIRELESS

The Buspro wireless range has been created to make home automation simple, adaptable, and easy to manage.

Able to be installed quickly, and with the reliability and functionality of a wired system, Buspro wireless enables you to monitor your home, control your lighting, open your blinds, and manage your connected appliances from anywhere in the world.

Compatible with most 3rd party automation solutions, and Buspro wired automation solutions, Buspro wireless is an automation evolution.



Lighting



Blind control



Curtain control



Air Conditioning



Background Music



Video Monitoring



What is Buspro Wireless?

Buspro Wireless is a distributed smart system developed by HDL. To install Buspro Wireless, you just simply replace the original non-smart keypad with the one from HDL. As no wiring is required, it is suitable for both new buildings as well as existing ones.

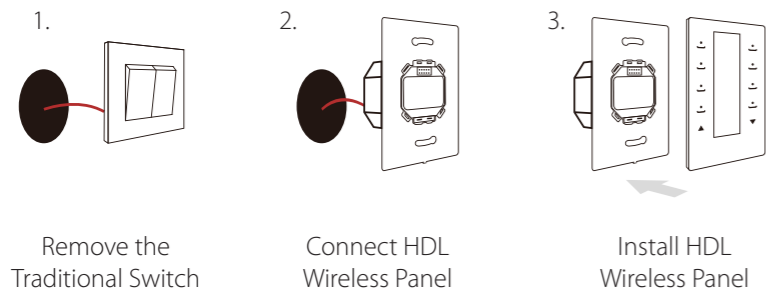

It adopts the robust mesh topology. That is every device in the system can receive and transmit signals. A reliable path is always available for communication.

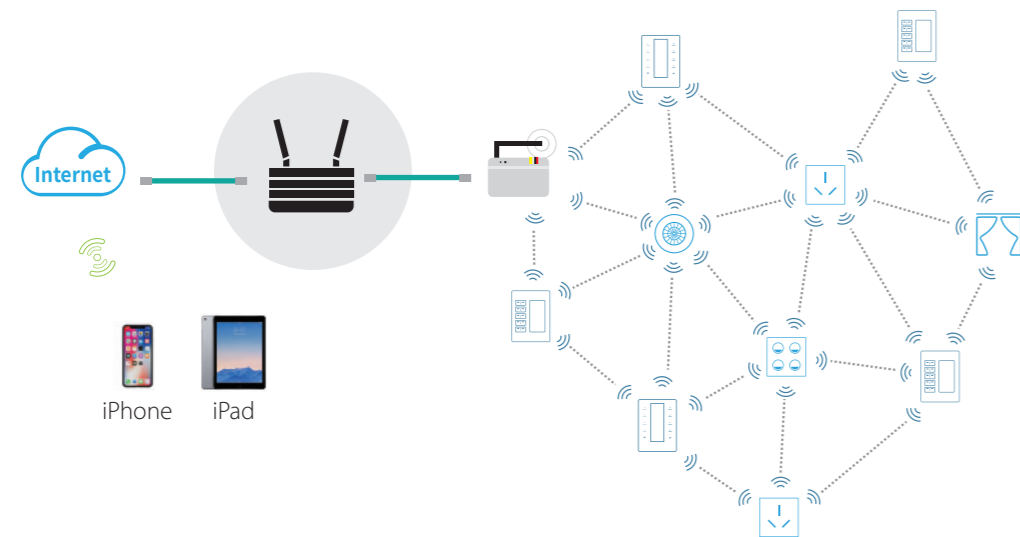

It runs on sub-giga Hertz frequency. That means it doesn't have to jam with mobile phones, laptops and other wireless devices running on the 2.4GHz bandwidth.

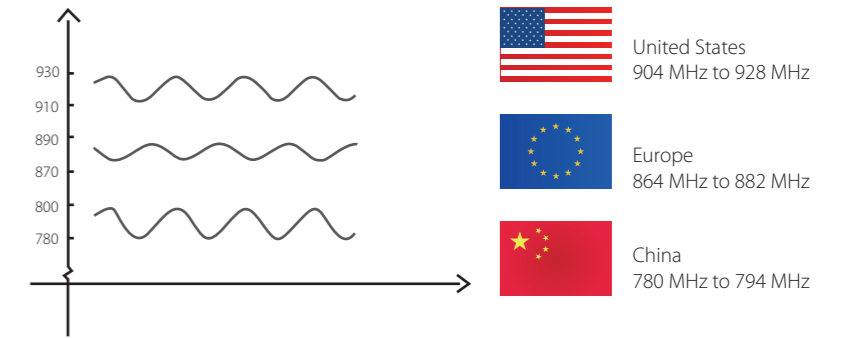

It can work with the wired Buspro system in the same project. The feature allows us to fully use the advantages of wired and wireless system, and makes the system more applicable.

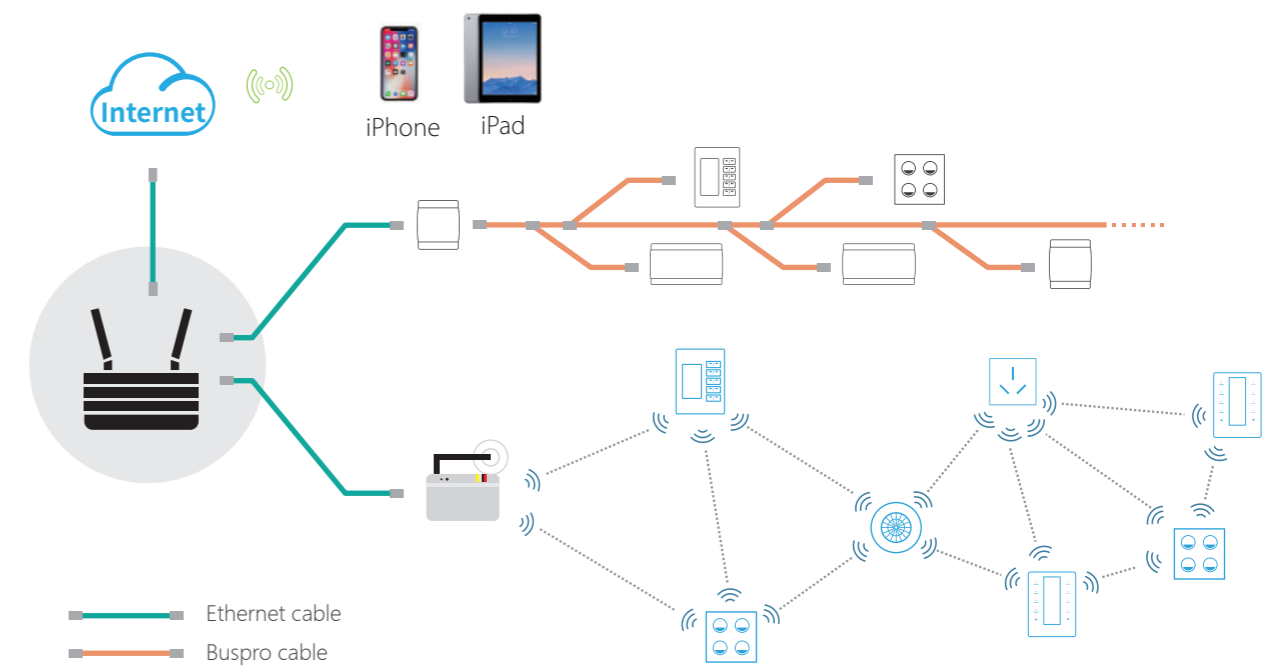

Control panels

The control panels of Buspro Wireless, from the user's perspective, serve for the same functions as those of the wired Buspro. They also share the same industrial design. However, they are so different inside.

- There are built-in smart modules in the power interfaces, such as relays and dimmers.
- The control panels directly connect with their targets via AC power cables.
- And of course, they communicate wirelessly.



Control
panels

So, here we will make it simple introducing these wireless panels. Take a look.



DLP



MPL8-RF.18-A

- **Working voltage:** DC 5V (from wireless power interface)
- **Power consumption:** 55mA / DC 5V
- **Indoor communication distance:** 30m(barrier free)
- **RSSI Received Signal Strength Indication:** >-80dbm

MPL8-RF.18-A	MPL8-RF.16-A
86 × 86 × 10.5(mm)	86×116.5×10.5(mm)
EU	US
110g	133g

iTouch



MPT4-RF.18-A

- **Working voltage:** DC 5V (from wireless power interface)
- **Wireless transmission power:** +10dbm
- **Wireless sensitivity:** -90dbm
- **Indoor communication distance:** 30m (Barrier free)
- **RSSI Received Signal Strength Indication:** >-80dbm

MPT4-RF.18-A	MPL8-RF.16-A	MPT6-RF.16-A	MPT4-RF.16-A	MPT2-RF.16-A
86 × 86 × 10.5(mm)	86 × 86 × 10.5(mm)	86×116.5×10.5(mm)	86×116.5×10.5(mm)	86×116.5×10.5(mm)
EU	EU	US	US	US
4 buttons	2 buttons	6 buttons	4 buttons	2 buttons
110g	110g	133g	133g	133g

iSmart



MPE04-RF.18

- Working voltage: DC 5V (from wireless power interface)
- Power consumption: 64mA / DC 5V
- Wireless transmission power: +10dbm
- Wireless sensitivity: -90dbm
- Indoor communication distance: 20m (barrier free)
- RSSI Received Signal Strength Indication: >-80dbm
- Dimensions: 55.5 × 55.5 × 16.8(mm)
- Weight: 30.3g

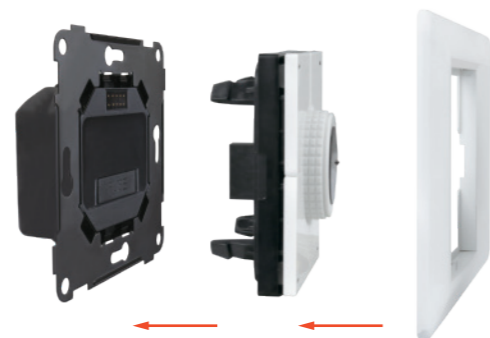

Power interface iSmart Panel Frame

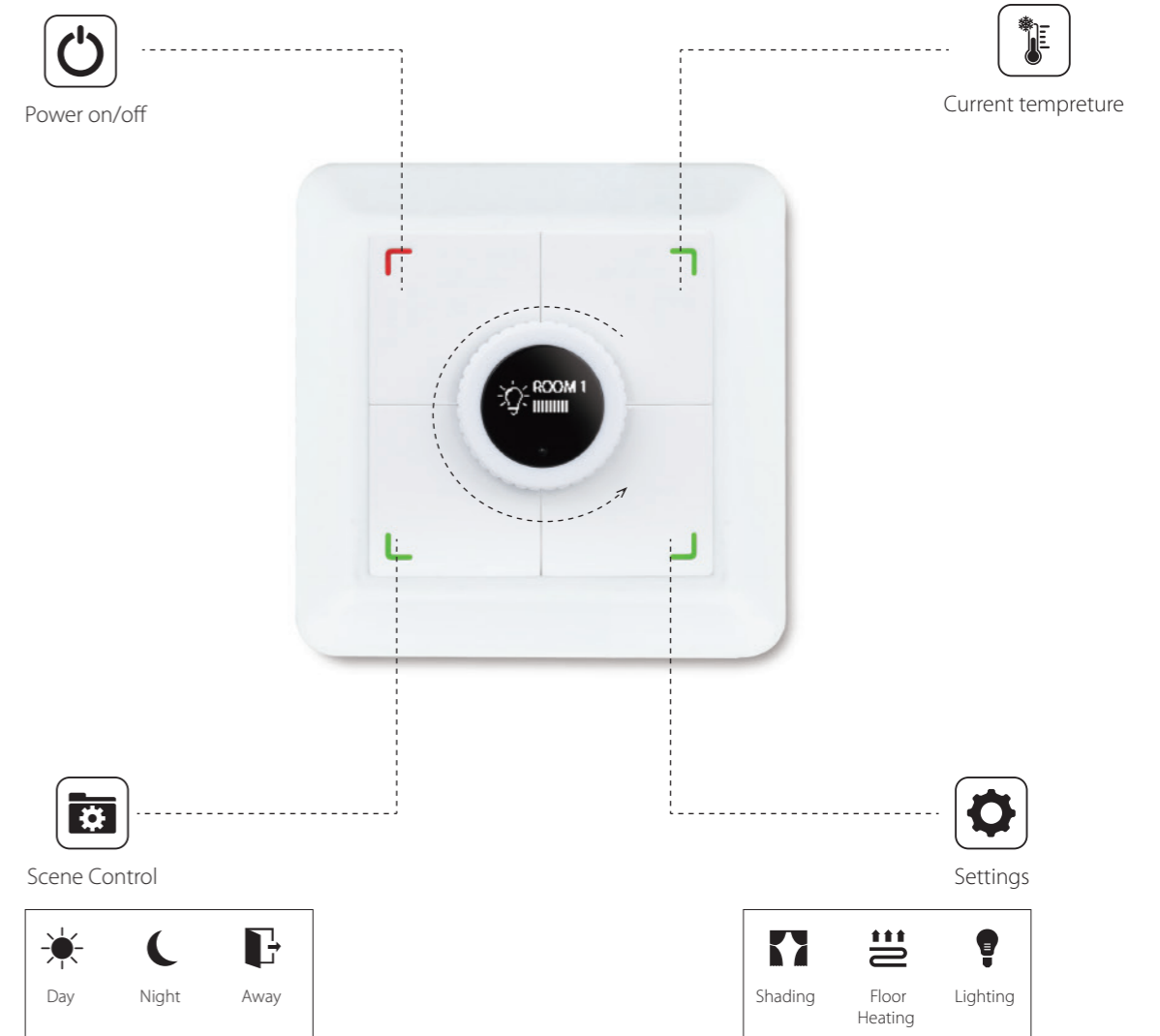

Customizable icons

By simply pressing the two bottom buttons simultaneously, a user can effortlessly enable or disable underfloor heating control.

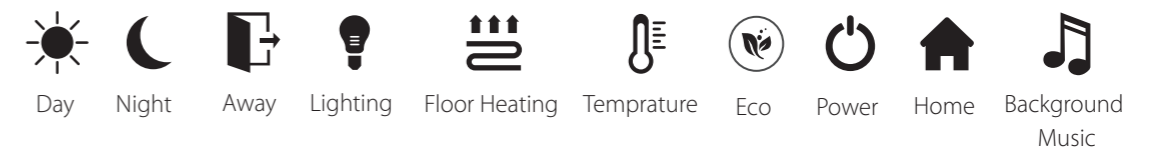



Power Interfaces (L+N Type)



MPWPID00LN.18-A

- Receives and transmit data
- No relays or dimmers inside
- **Working voltage:** AC 100-240V, 50/60Hz
- **The maximum output current:**100mA / DC 5V

MPWPID00LN.18-A	MPWPID00LN.16-A
80×80×39(mm)	80×110.5×39(mm)
EU	US
128g	138g



MPWPID00LN.16-A

3CH Dimmer Power Interface (L Type)

- Working voltage: AC100-240V 50/60Hz
- 3 output channels
- 1 channel for MOSFET dimmer
- 2 channels for TRIAC dimmers
- Output current: 1st channel $\leq 1.2A$ 2nd and 3rd channel total current $\leq 2A$



MPWPID03L.18-A



MPWPID03L.16-A

MPWPID03L.18-A	MPWPID03L.16-A
80x80x39(mm)	80x110.5x39(mm)
EU	US
128g	138g

3CH Dimmer Power Interface (L+N Type)

- Working voltage: AC85-270V 50/60Hz
- 3 output channels
- 1 channel for MOSFET dimmer
- 2 channels for TRIAC dimmers
- Output current: 1st channel $\leq 1.2A$ 2nd and 3rd channel total current $\leq 2A$



MPWPID03LN.18-A



MPWPID03LN.16-A

MPWPID03LN.18-A	MPWPID03LN.16-A
80x80x39(mm)	80x110.5x39(mm)
EU	US
128g	138g

3CH Relay Power Interface (L+N Type)

- Working voltage: AC85-270V 50/60Hz
- 3 relay output channels
- Output current: AC 3A 250V (resistive load), AC 2A 250V (capacitive load)



MPWPIR03.18-A



MPWPIR03.16-A

MPWPIR03.18-A	MPWPIR03.16-A
80×80×39(mm)	80×110.5×39(mm)
EU	US
128g	138g

1CH Relay Power Interface (L+N Type)

- Working voltage: AC85-270V 50/60Hz
- 1 relay output channel
- Built-in temperature sensor
- Output current: 16A 250VAC



MPWPIR01T.18-A



MPWPIR01T.16-A

MPWPIR01T.18-A	MPWPIR01T.16-A
80×80×39(mm)	80×110.5×39(mm)
EU	US
128g	138g

1CH Dimmer (L+N Type)

Able to be placed in practically any location due to its compact size, the 1CH Dimmer is able to wirelessly control the luminosity of lights directly.

This allows customized illumination levels to be created, and a user to control their lighting from any HDL keypad, panel, or compatible wireless app.

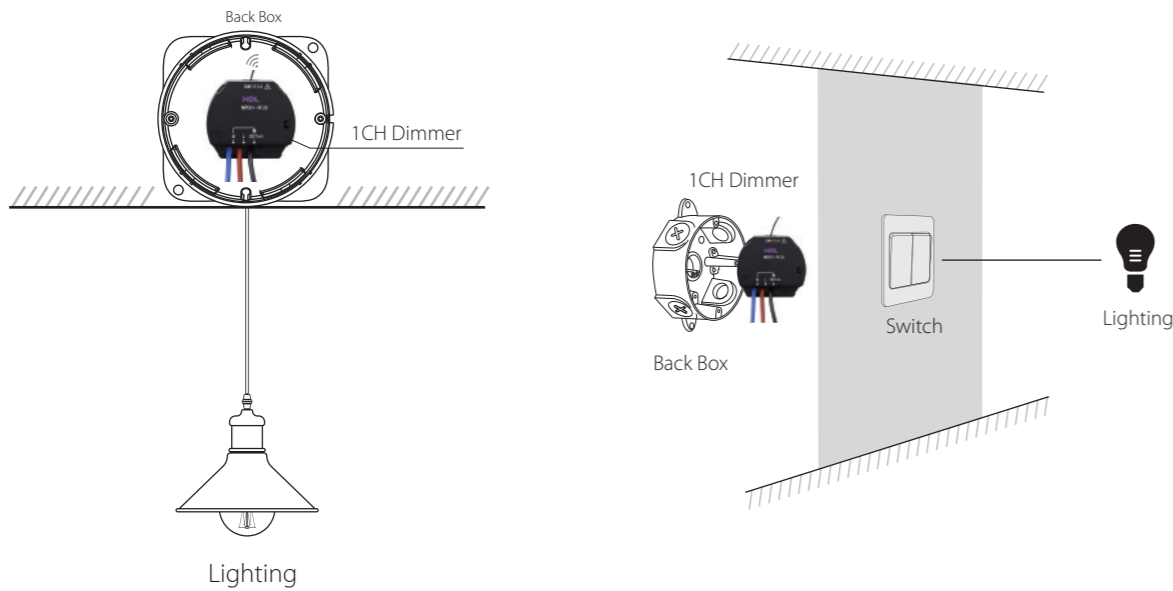

MPD01-RF.28

- **Input voltage:** AC100-240V(50/60Hz)
- **Maximum output current:** 1A
- **Power consumption:** 1W max.
- 4 dry contact channels
- **Wireless transmission power:** +10dbm
- **Wireless sensitivity:** -90dbm
- **Indoor communication distance:** <=30m
- **RSSI received signal strength indication:** >-80dbm
- **Dimensions:** 52x46.5x24(mm)
- **Net weight:** 36g

4CH Ballast Dimmer (L+N Type)



MPDA04-RF.28

- **Input voltage:** AC100-240V(50/60Hz)
- **Power consumption:** 2.7W max.
- 4 dry contact channels
- 4 dimmer channels
- **Current of each 0-10VDC output channel:** 0-30mA
- **Wireless transmission power:** +10dbm
- **Wireless sensitivity:** -90dbm
- **Indoor communication distance:** <=30m
- **RSSI Received Signal Strength Indication:** >-80dbm
- **Dimensions:** 52x46.5x20(mm)
- **Net weight:** 33g

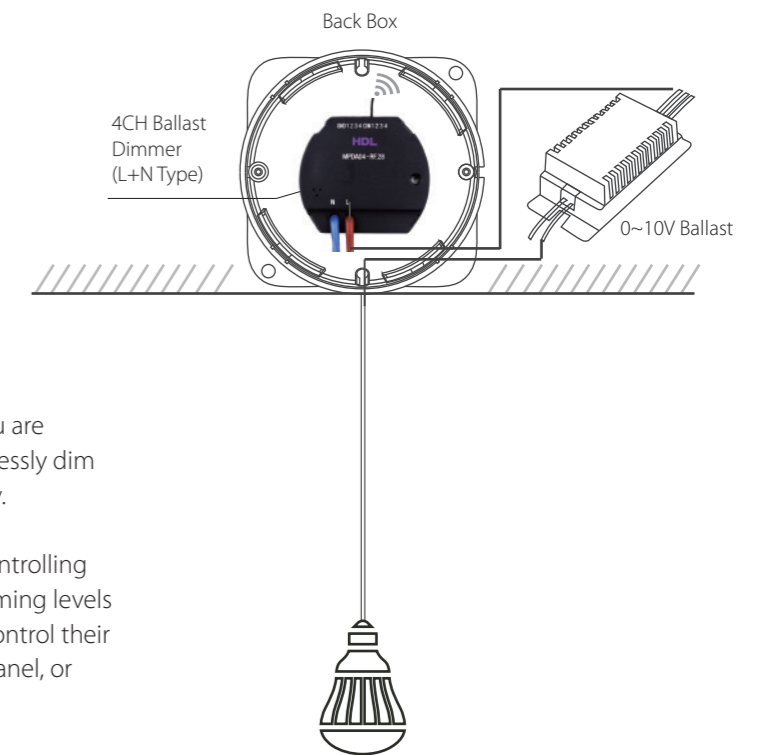

LED Lamp

With the 4CH Ballast Dimmer you are provided with the ability to wirelessly dim any type of LED lighting instantly.

Via the Four Channel Dimmer controlling the LED ballast, customized dimming levels can be created, and a user can control their lighting from any HDL keypad, panel, or compatible wireless app.

1CH Relay (L+N Type)



MPR01-RF.28

- **Input voltage:** AC100-240V(50/60Hz)
- **Power consumption:** 1.7W max.
- 4 dry contact channels
- 4 dimmer channels
- **DC 0-10V output for each dimmer channel:** 0-30mA
- **Wireless transmission power:** +10dbm
- **Wireless sensitivity:** -90dbm
- **Indoor communication distance:** <=30m
- **RSSI Received Signal Strength Indication:** >-80dbm
- **Dimensions:** 52x46.5x20(mm)
- **Net weight:** 40g

2CH Relay (L+N Type)



MPR02-RF.28

- **Input voltage:** AC100-240V(50/60Hz)
- 4 dry contact channels
- 2 relay channels
- **Power consumption:** 1.45W max
- **Wireless transmission power:** +10dbm
- **Wireless sensitivity:** -90dbm
- **Indoor communication distance:** <=30m
- **RSSI Received Signal Strength Indication:** >-80dbm
- **Dimensions:** 52x46.5x24(mm)
- **Net weight:** 45.5g

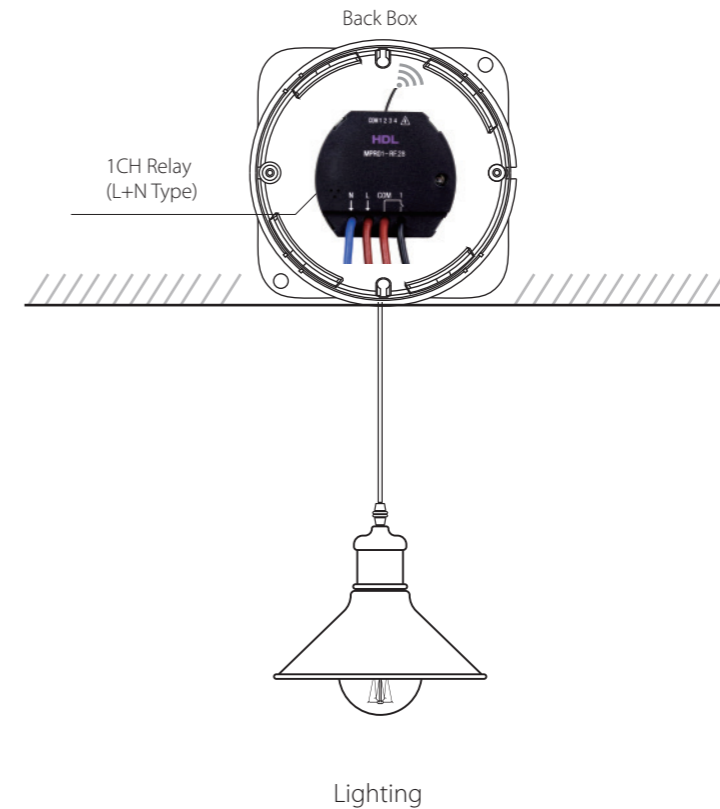

Installed in the ceiling, a wireless relay is the perfect solution for wirelessly switching your lighting on and off.

If a wireless relay is installed into a standard switch back box, it will be able to control appliances and devices through communicating with either the SmartSocket or the IR Controller.

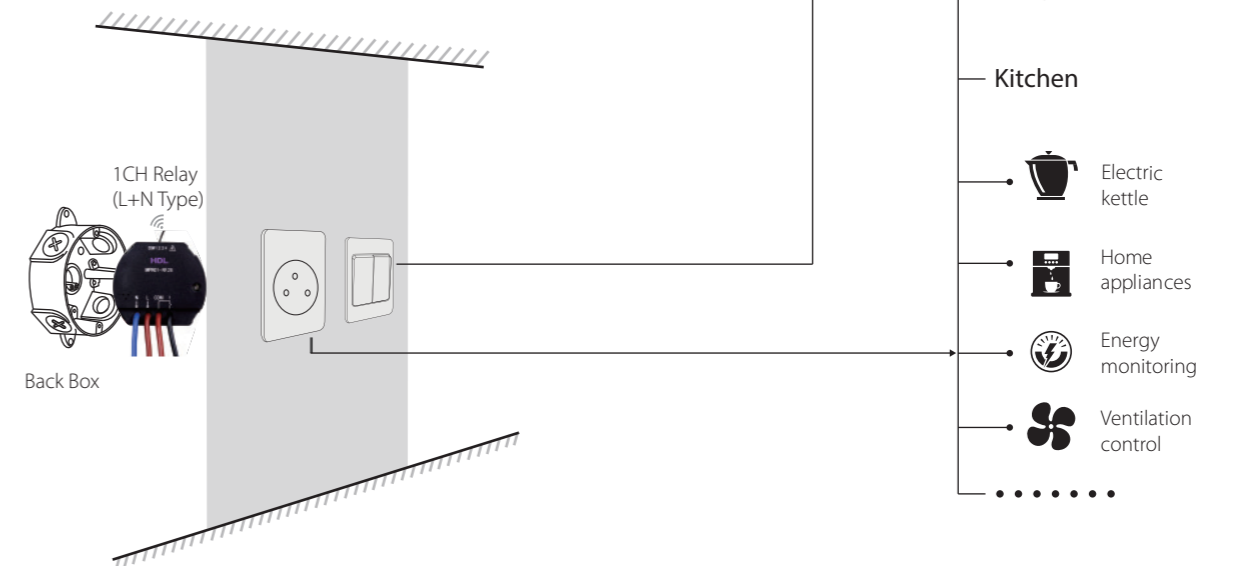

IR Emitter

Designed to control all IR devices and appliances, the IR Emitter brings you a centralized IR management solution for televisions, air conditioners, DVD players, home cinemas, and other IR controlled devices.

With a comprehensive list of in-built IR codes, the emitter is capable of controlling most devices from major manufactures instantly.

If your device is not included in the IR library, the IR Emitter can be updated via the HDL IR learner.



MIR01R-RF.10

- Working power: 5V DC (From USB)
- Working current: 20mA / 5V DC
- IR emission carrier frequency: 38KHz
- IR Control distance (channel 1): 5m
- Indoor communication distance: <=30m (barrier free)
- RSSI Received Signal Strength Indication: >-80dbm
- Dimensions: Φ 120x37 (mm)
- Net weight: 125g

- Control IR devices from a HDL wall panel or your mobile device
- Enables full control over all IR devices
- Supports online upgrades
- Build a custom IR library

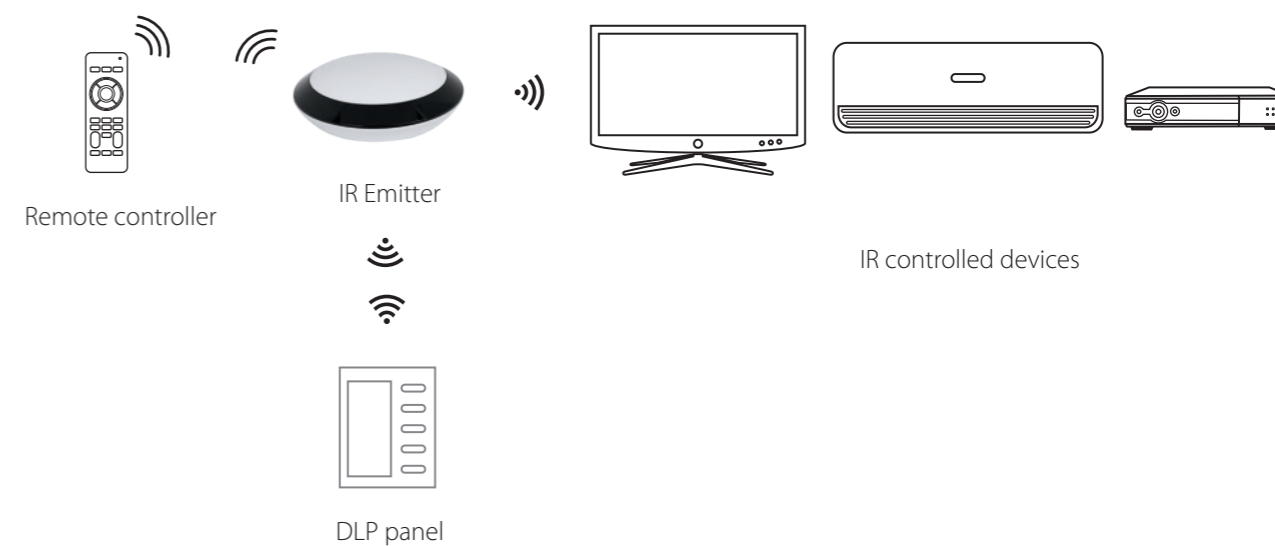



1CH Curtain Controller (L+N Type)



MPC01-RF.18

- Input voltage: AC100-240V(50/60Hz)
- Output current: 5A
- 1 curtain control channel
- 4 dry contact channels
- Power consumption: 1.45W max
- Wireless transmission power: +10dbm
- Wireless sensitivity: -90dbm
- Indoor communication distance: <=30m
- RSSI Received Signal Strength Indication: >-80dbm
- Dimensions: 52x46.5x24(mm)
- Net weight: 45g

Curtain Motor



Master



MWM70-RF.12

- Open, close, stop and percentage control of curtains
- Rated voltage: AC 220V, 50Hz
- Voltage range: AC 220V±20%, 50HZ
- Slave interface: 6P internet port
- Rated power: 70W
- Rated torque: 1.0Nm
- Rated speed: 112rpm
- Rail belt speed: 16cm/s
- Wireless transmission power: +10dbm
- Wireless sensitivity: -90dbm
- Indoor communication distance: 30m (barrier free)
- RSSI Received Signal Strength Indication: >-80dbm
- Dimensions: 284x70x50 (mm)
- Net weight: 1352g

Ultrasonic Sensor



MSPU05-RF.1c

- Built-in ultrasonic sensor, PIR sensor, universal switch
- **Working voltage:** AC100-240V (50/60Hz)
- **Working current:** 5mA/220V AC
- **Relay output:** 5A
- **Brightness detection range:** 0~300LUX
- **PIR detection range (Radius):** 7m (Installation height: 3m)
- **Ultrasonic detection range (Radius):** 5m (Installation height: 3m)
- **Wireless transmission power:** +10dbm
- **Wireless sensitivity:** -90dbm
- **Indoor communication distance:** <=30m
- **RSSI Received Signal Strength Indication:** >-80dbm
- **Dimension:** $\Phi 95 \times 38$ mm
- **Net weight:** 280g

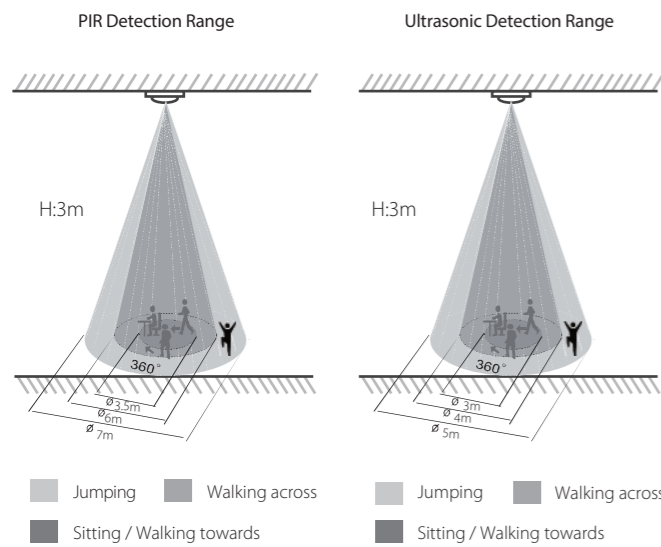

Ultrasonic Detection Range At 31			
Mounting height	Sitting / Walking towards	Walking across	Jumping
3m	3m	4m	5m

PIR Detection Range At 31			
Mounting height	Sitting / Walking towards	Walking across	Jumping
3m	3.5m	6m	7m

PIR & Lux Sensor



MSPU05-RF.1c

- Built-in PIR sensor, light sensor, temperature sensor
- **Working voltage:** 3V 1400mAh (From battery)
- **Working current:** 21mA
- **Standby current:** 24 μ A
- **Indoor communication distance:** <=30m
- **RSSI Received Signal Strength Indication:** >-80dbm
- **Dimension:** 54 x 54 x 51.5(mm)
- **Net weight:** 125g

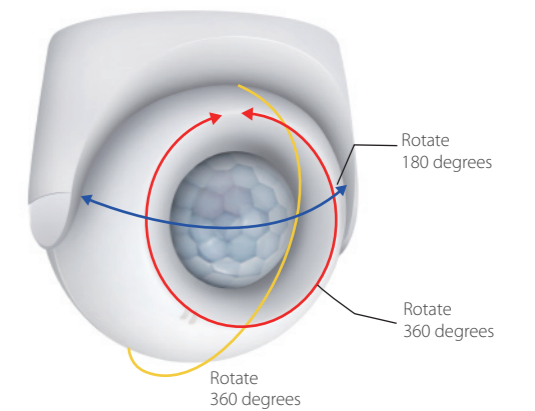
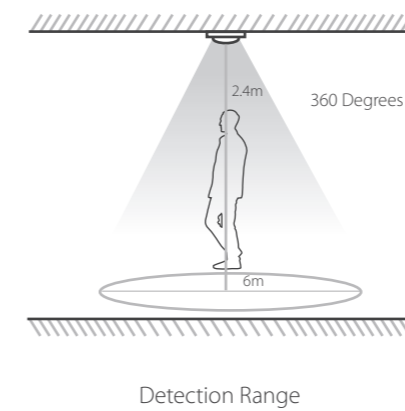

Gateways

Mesh Gateway



MCIP-RF02.10

- Working power: DC 24V
- Communication: RJ45, HDL Buspro, RF
- Wireless transmission power: +10dbm
- Indoor communication distance: <=50m (barrier free)
- Frequency: SubG
- RSSI Received Signal Strength Indication: >-80dbm
- Dimensions: 107 × 99.5 × 27 (mm)
- Net weight: 212g

Triple communication interfaces

The wireless MCIP-RF02.10 Gateway supports three essential communication types, RJ45, HDL-Buspro, and RF. These communication methods allow a user to control the wireless system via a pad or smart phone, while maintaining conventional wired system functionality.



RJ45

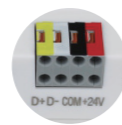

HDL-BUS



Wireless

Wireless Central Frequency

(China) WPAN: 780MHz-786MHz

(Europe) SRD: 864MHz -870MHz

(North America) ISM: 904MHz -928MHz

Dual working modes

Employing two working modes, the Gateway can function in both mesh working mode and bridge network mode.

In the mesh network mode all devices active in the network are able to communicate with each other, and a wired system can be integrated into the system via the RJ45 and HDL Buspro ports.

When in the bridge working mode, the Gateway acts as a transmission bridge. This enables multiple gateways and their associated devices to wirelessly communicate with each other.

Mesh working mode

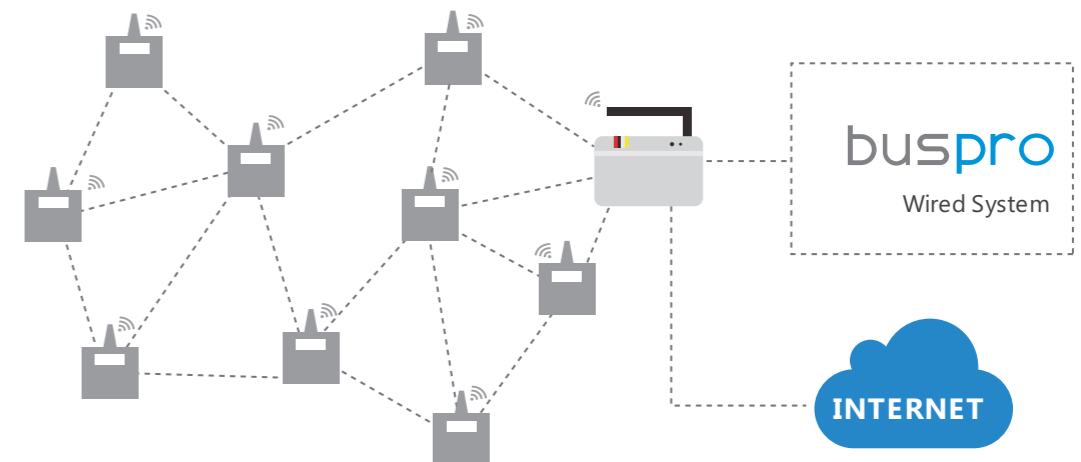

Bridge working mode

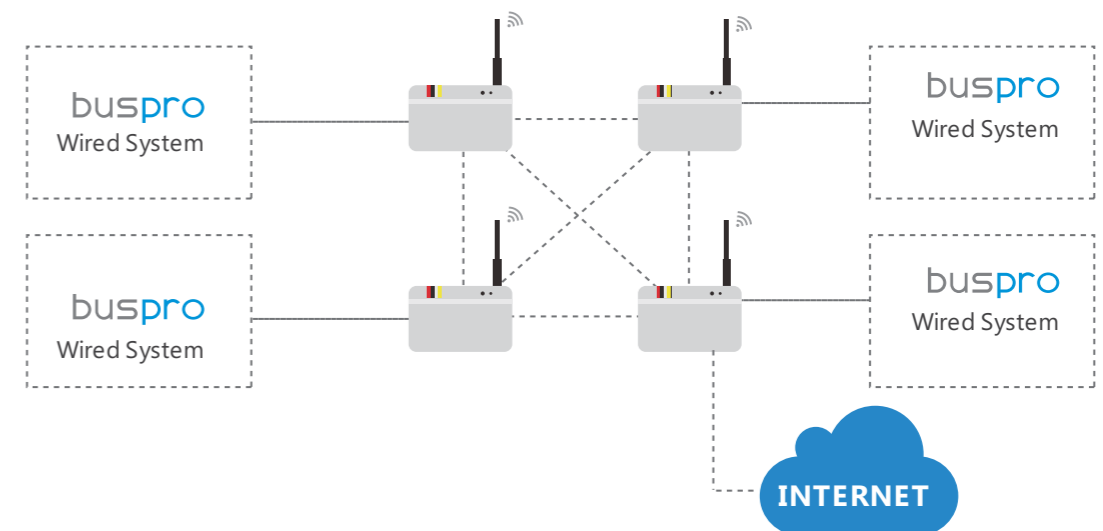

Gateways

4CH Dry Contact



MPS04-RF.18

- Input voltage: AC 100-240V (50/60Hz)
- Power consumption: 0.3W max
- Wireless transmission power: +10dbm
- Wireless sensitivity: -90dbm
- Indoor communication distance: ≤30m
- RSSI Received Signal Strength Indication: >-80dbm
- Dimensions: 52x46.5x20(mm)
- Net weight: 31g

Buspro / Wireless Converter



MBUS/GW-RF.40

- Translate Buspro (wired) into Buspro Wireless
- Input voltage: AC 85~260V, 50/60Hz
- Power consumption: 1.15W
- Output: DC 24V, 100mA
- Wireless transmission power: +10dbm
- Wireless sensitivity: -90dbm
- Indoor communication distance: ≤30m (barrier free)
- RSSI received signal strength indication: >-80dbm
- Dimensions: 48.2 x 43.6 x 21.3 (mm)
- Weight: 38g

